

# R&S® NGE100B Power Supply User Manual



5601134302

This manual describes the following R&S®NGE100B models and options:

- R&S®NGE102B 2-Channel PSU (5601.3800.02)
- R&S®NGE103B 3-Channel PSU (5601.3800.03)
- R&S®NGE-K101 Ethernet Remote Control (5601.2204.03)
- R&S®NGE-K102 Wireless LAN Remote Control (5601.2210.03)
- R&S®NGE-K103 Digital Trigger I/O (5601.2227.03)

The contents of this manual correspond to firmware version 1.50 or higher.

The software contained in this product uses several valuable open source software packages. For information, see the "Open Source Acknowledgment" document, which is available for download from the R&S NGE100B product page at [www.rohde-schwarz.com/product/nge100b](http://www.rohde-schwarz.com/product/nge100b) > "Downloads" > "Firmware".

Rohde & Schwarz would like to thank the open source community for their valuable contribution to embedded computing.

© 2018 Rohde & Schwarz GmbH & Co. KG

Mühlhofstr. 15, 81671 München, Germany

Phone: +49 89 41 29 - 0

Fax: +49 89 41 29 12 164

Email: [info@rohde-schwarz.com](mailto:info@rohde-schwarz.com)

Internet: [www.rohde-schwarz.com](http://www.rohde-schwarz.com)

Subject to change – Data without tolerance limits is not binding.

R&S® is a registered trademark of Rohde & Schwarz GmbH & Co. KG.

Trade names are trademarks of the owners.

5601.1343.02 | Version 02 | R&S®NGE100B

The following abbreviations are used throughout this manual: R&S®NGE100B is abbreviated as R&S NGE100B. R&S® is abbreviated as R&S.

# Safety Instructions

## Instrucciones de seguridad

## Sicherheitshinweise

## Consignes de sécurité

---

**⚠ WARNING****Risk of injury and instrument damage**

The instrument must be used in an appropriate manner to prevent electric shock, fire, personal injury or instrument damage.

- Do not open the instrument casing.
- Read and observe the "Basic Safety Instructions" delivered as printed brochure with the instrument.
- Read and observe the safety instructions in the following sections. Note that the data sheet may specify additional operating conditions.
- Keep the "Basic Safety Instructions" and the product documentation in a safe place and pass them on to the subsequent users.

---

**⚠ ADVERTENCIA****Riesgo de lesiones y daños en el instrumento**

El instrumento se debe usar de manera adecuada para prevenir descargas eléctricas, incendios, lesiones o daños materiales.

- No abrir la carcasa del instrumento.
- Lea y cumpla las "Instrucciones de seguridad elementales" suministradas con el instrumento como folleto impreso.
- Lea y cumpla las instrucciones de seguridad incluidas en las siguientes secciones. Se debe tener en cuenta que las especificaciones técnicas pueden contener condiciones adicionales para su uso.
- Guarde bien las instrucciones de seguridad elementales, así como la documentación del producto, y entréguelas a usuarios posteriores.

---

**⚠️ WARNUNG****Gefahr von Verletzungen und Schäden am Gerät**

Betreiben Sie das Gerät immer ordnungsgemäß, um elektrischen Schlag, Brand, Verletzungen von Personen oder Geräteschäden zu verhindern.

- Öffnen Sie das Gerätegehäuse nicht.
  - Lesen und beachten Sie die "Grundlegenden Sicherheitshinweise", die als gedruckte Broschüre dem Gerät beiliegen.
  - Lesen und beachten Sie die Sicherheitshinweise in den folgenden Abschnitten; möglicherweise enthält das Datenblatt weitere Hinweise zu speziellen Betriebsbedingungen.
  - Bewahren Sie die "Grundlegenden Sicherheitshinweise" und die Produktdokumentation gut auf und geben Sie diese an weitere Benutzer des Produkts weiter.
- 

---

**⚠️ AVERTISSEMENT****Risque de blessures et d'endommagement de l'appareil**

L'appareil doit être utilisé conformément aux prescriptions afin d'éviter les électrocutions, incendies, dommages corporels et matériels.

- N'ouvrez pas le boîtier de l'appareil.
  - Lisez et respectez les "consignes de sécurité fondamentales" fournies avec l'appareil sous forme de brochure imprimée.
  - Lisez et respectez les instructions de sécurité dans les sections suivantes. Il ne faut pas oublier que la fiche technique peut indiquer des conditions d'exploitation supplémentaires.
  - Gardez les consignes de sécurité fondamentales et la documentation produit dans un lieu sûr et transmettez ces documents aux autres utilisateurs.
-

# Contents

<b>1</b>	<b>Preface.....</b>	<b>7</b>
1.1	<b>Documentation Overview.....</b>	<b>7</b>
1.2	<b>Conventions Used in the Documentation.....</b>	<b>8</b>
1.2.1	Typographical Conventions.....	8
1.2.2	Other Conventions.....	8
<b>2</b>	<b>Welcome to R&amp;S NGE100B.....</b>	<b>9</b>
<b>3</b>	<b>Important Notes.....</b>	<b>10</b>
3.1	<b>Symbols.....</b>	<b>10</b>
3.2	<b>Ambient Conditions.....</b>	<b>10</b>
3.3	<b>Measurement Categories.....</b>	<b>11</b>
3.4	<b>Mains Voltage.....</b>	<b>11</b>
3.5	<b>Limits.....</b>	<b>12</b>
<b>4</b>	<b>Quick Start.....</b>	<b>13</b>
4.1	<b>Putting into Operation.....</b>	<b>13</b>
4.1.1	Safety.....	14
4.1.2	Intended Operation.....	15
4.1.3	Unpacking and Checking the Instrument.....	17
4.1.4	Setting Up the Instrument.....	17
4.1.4.1	Bench Operation.....	18
4.1.4.2	Rack Mounting.....	18
4.2	<b>Instrument Tour.....</b>	<b>19</b>
4.2.1	Overview of Controls.....	19
4.2.1.1	Front Panel.....	19
4.2.1.2	Rear Panel.....	20
4.2.2	Switching On the Instrument.....	22
4.3	<b>Trying Out the Instrument.....</b>	<b>23</b>
4.3.1	Selecting the Channels.....	23
4.3.2	Setting the Output Voltage and Current Limit.....	23
4.3.3	Activating the Channels Output.....	23
4.3.4	Storing/Recalling of Instrument Settings.....	23

<b>4.4</b>	<b>Maintenance.....</b>	<b>24</b>
<b>5</b>	<b>Instrument Functions.....</b>	<b>25</b>
<b>5.1</b>	<b>User Interface.....</b>	<b>25</b>
5.1.1	Screen Layout.....	25
5.1.2	Function Keys.....	28
5.1.3	Virtual Keyboard.....	29
5.1.4	Navigation Controls.....	30
5.1.4.1	Rotary Knob.....	31
5.1.4.2	Arrow Keys.....	31
5.1.4.3	Live-Mode.....	31
5.1.5	Menu.....	32
<b>5.2</b>	<b>Power Derating.....</b>	<b>34</b>
<b>5.3</b>	<b>Output Modes.....</b>	<b>34</b>
<b>5.4</b>	<b>Basic Functions.....</b>	<b>35</b>
5.4.1	Setting the Channels Voltage and Current.....	35
5.4.2	Tracking Function.....	36
5.4.3	Activating Fuse.....	37
5.4.4	Activating the Channels Output.....	38
5.4.5	Store and Recall.....	38
<b>5.5</b>	<b>Advanced Functions.....</b>	<b>40</b>
5.5.1	Protection.....	40
5.5.2	Fuse.....	42
5.5.3	EasyArb.....	43
5.5.4	EasyRamp.....	44
5.5.5	Digital Trigger I/O.....	45
<b>5.6</b>	<b>Connecting to a Network.....</b>	<b>48</b>
5.6.1	LAN Connection.....	48
5.6.1.1	Wired Connection.....	48
5.6.1.2	Wireless Connection.....	50
5.6.2	USB Connection.....	51
<b>5.7</b>	<b>General Instrument Settings.....</b>	<b>52</b>
5.7.1	Instrument Information.....	52
5.7.2	General Instrument Settings.....	53

5.7.3	Managing Options.....	54
5.7.4	Reset Instrument.....	55
5.7.5	System Test.....	55
5.7.6	Updating the Firmware.....	56
5.7.7	Help.....	57
<b>6</b>	<b>Remote Control.....</b>	<b>59</b>
<b>6.1</b>	<b>Interfaces and Protocols.....</b>	<b>59</b>
6.1.1	USB.....	59
6.1.1.1	USB VCP.....	59
6.1.1.2	USB TMC.....	60
6.1.2	LAN.....	61
6.1.3	WLAN.....	61
6.1.4	LXI.....	62
6.1.5	SCPI.....	63
6.1.6	VISA.....	64
<b>6.2</b>	<b>Setting Up Remote Control Connection.....</b>	<b>64</b>
<b>6.3</b>	<b>SCPI Command Structure and Syntax.....</b>	<b>65</b>
6.3.1	Structure of a Command.....	65
6.3.1.1	Common Commands.....	65
6.3.1.2	Device-Specific Commands.....	66
6.3.1.3	Overview of Syntax Elements.....	69
6.3.2	Parameters.....	70
6.3.2.1	Numeric Values.....	70
6.3.2.2	Special Numeric Values.....	70
6.3.2.3	Boolean Parameters.....	71
6.3.2.4	Text.....	71
6.3.2.5	Strings.....	71
6.3.2.6	Block Data.....	72
6.3.3	Structure of a Program Message.....	72
6.3.4	Responses to Queries.....	72
<b>6.4</b>	<b>Command Sequence and Command Synchronization.....</b>	<b>73</b>
<b>6.5</b>	<b>Remote Control - Commands.....</b>	<b>73</b>
6.5.1	Common Commands.....	74

6.5.2	System Commands.....	76
6.5.3	Firmware Update.....	79
6.5.4	HCOPY.....	79
6.5.5	Channel Selecting.....	79
6.5.6	Output Setting.....	80
6.5.7	Fuse Setting.....	83
6.5.8	OVP Setting.....	85
6.5.9	OPP Setting.....	86
6.5.10	Measurement Commands.....	88
6.5.11	Voltage and Current Configuration Commands.....	89
6.5.12	EasyRamp Commands.....	90
6.5.13	Arbitrary Commands.....	91
6.5.14	DIO Commands.....	93
<b>7</b>	<b>Applications.....</b>	<b>98</b>
<b>7.1</b>	<b>Parallel and Serial Mode.....</b>	<b>98</b>
7.1.1	Serial Mode.....	98
7.1.2	Parallel Mode.....	99
	<b>Index.....</b>	<b>101</b>



# 1 Preface

## 1.1 Documentation Overview

This section provides an overview of the R&S NGE100B user documentation. You find it on the product page at:

<http://www.rohde-schwarz.com/product/nge100b> > "Downloads"

### Getting started manual

Introduces the R&S NGE100B and describes how to set up and start working with the product. A printed version is included in the delivery.

### User manual

The user manual contains the description of all instrument modes and functions. It also provides an introduction to remote control, a complete description of the remote control commands with programming examples, and information on maintenance, instrument interfaces and error messages.

### Service manual

The service manual is available for registered users on the global Rohde & Schwarz information system (GLORIS, <https://gloris.rohde-schwarz.com>).

### Basic safety instructions

Contains safety instructions, operating conditions and further important information. The printed document is included in the delivery.

### Brochure

The brochure provides an overview of the R&S NGE100B and shows its specific characteristics. The technical specifications of the R&S NGE100B are included in the brochure. It also lists the options and their order numbers as well as optional accessories.

### Calibration certificate

The calibration certificates of your device are available online. Visit the R&S NGE100B product page and select the item to download the calibration certificate. You will be forwarded to a Gloris page.

<https://gloris.rohde-schwarz.com/calcert>.

Enter the device ID of your R&S NGE100B and download the certificate. You can find the device ID either in the "Setup" menu or on the label on the rear panel.

**Release notes and open source acknowledgment (OSA)**

The release notes list new features, improvements and known issues of the current firmware version, and describe the firmware installation.

The open source acknowledgment document provides verbatim license texts of the used open source software.

See <http://www.rohde-schwarz.com/product/nge100b> > "Downloads" > "Firmware".

**Application notes, application cards, white papers, etc.**

These documents contain information about possible applications and background information on various topics, see [www.rohde-schwarz.com/apnotes](http://www.rohde-schwarz.com/apnotes).

## 1.2 Conventions Used in the Documentation

The following conventions are used throughout the R&S NGE100B manual.

### 1.2.1 Typographical Conventions

Convention	Description
"Graphical user interface elements"	Names of graphical user interface elements on the screen, such as dialog boxes, menus, options, buttons, and softkeys are enclosed by quotation marks.
<b>Keys</b>	Name of key is bolded.
<code>filenames, commands, program code</code>	File names, commands, coding samples and screen output are distinguished by their fonts.
<i>Input</i>	User input is displayed in italics.
<a href="#">Links</a>	Links are displayed as underlined.
"References"	References to other parts of the documentation are enclosed by quotation marks.

### 1.2.2 Other Conventions

Remote commands may include abbreviations to simplify input. In the description of such commands, all parts that have to be entered are written in capital letters.

Additional text in lowercase characters is for information only.

## 2 Welcome to R&S NGE100B

The two or three-channels power supply series are based on a classical transformer concept with high efficiency electronic pre-regulators and secondary linear regulators. This concept allows the instrument to achieve the high output power within a minimum space, high efficiency and lowest residual ripple.

The R&S NGE100B power supply series feature galvanically isolated, floating overload and short-circuit proof outputs with adjustable power ratings. The outputs can be connected in series or in parallel, thus making high currents and voltages available.

Multi-purpose protection functions are available for each channel which you can set separately, such as overcurrent protection (FUSE), overvoltage protection (OVP), over-power protection (OPP) and overtemperature protection (OTP). If such a limit is reached, the affected output channel is automatically turned off and an indicator message (FUSE, OVP, OPP or OTP) is displayed. The overcurrent protection can be linked to other channel (FuseLink function). In this case, all linked channels are turned off when the set channel reaches its limit.

The EasyArb function allows channel 1 (Ch 1) to have a freely definable voltage and current sequences with a timeframe as short as 10 ms. It allows you to vary the voltage or current limit during a test sequence, for example to simulate different charging conditions of a battery. With EasyRamp function, the R&S NGE100B provides the operating condition to simulate the continuous rise of the supply voltage within a defined timeframe of 10 ms to 10 s.

Four data lines of the digital I/O interface are mutually independent and can be used as trigger input or trigger output separately. Various trigger conditions (e.g. fuse tripped, voltage, current, indicator messages) can be used to turn off, on or invert the output state when the trigger condition is met.







All R&S NGE100B power supply series are equipped with a color LCD display (320 x 240 pixels resolution). The R&S NGE100B comes with a USB interface and optional LAN (LXI) and wireless LAN (WLAN) interface.

For models with WLAN, network connection can also be established wirelessly.

This user manual contains a description of the functionalities that the instrument provides. The latest version is available for download at the product homepage (<http://www.rohde-schwarz.com/product/nge100b>).

## 3 Important Notes

### 3.1 Symbols

	Caution, general danger zone
	Ground
	PE terminal
	ON (supply voltage)
	OFF (supply voltage)
	Ground terminal

### 3.2 Ambient Conditions

The allowed operating temperature ranges from +0 °C to +40 °C (pollution category 2). The maximum relative humidity (without condensation) is at 80 %.

During storage and transport, the temperature must be between -20 °C and +70 °C. In case of condensation during transportation or storage, the instrument will require approximately two hours to dry and reach the appropriate temperature prior to operation. The instrument is designed for use in a clean and dry indoor environment. Do not operate with high dust and humidity levels, if danger of explosion exists or with aggressive chemical agents.

Any operating position may be used; however adequate air circulation must be maintained. For continuous operation, a horizontal or inclined position (integrated stand) is preferable.

Specifications with tolerance data apply after a warm up period of at least 30 minutes at a temperature of 23 °C (tolerance -3 °C/+ 7 °C). Specifications without tolerance data are average values.

The heat produced inside the instrument is guided to the exterior via temperature-controlled fan. Each channel has multiple temperature sensors which check the heat generation in the instrument and control the fan speed.

It is necessary to ensure that there is sufficient space around the instrument sides for heat exchange. If the temperature inside the instrument increases to more than

~72 °C, a channel-specific overheat protection intervenes. Affected outputs will automatically be switched off.

**⚠ CAUTION****Air circulation**

Do not obstruct the ventilation holes!

### 3.3 Measurement Categories

This instrument is designed for supplying power on circuits that are only indirectly connected to the low voltage mains or not connected at all. The instrument is not intended for measurements within the measurement categories II, III or IV; the maximum potential against earth generated by the user must not exceed 150 VDC in this application.

The following information refers solely to user safety. Other aspects, such as the maximum voltage, are described in the technical data and must also be observed.

The measurement categories refer to transients that are superimposed on the mains voltage. Transients are short, very fast (steep) current and voltage variations which may occur periodically and non-periodically. The level of potential transients increases as the distance to the source of the low voltage installation decreases.

- Measurement CAT IV: Measurements at the source of the low voltage installations (e.g. meters)
- Measurement CAT III: Measurements in building installations (e.g. power distribution installations, power switches, firmly installed sockets, firmly installed engines etc.)
- Measurement CAT II: Measurements on circuits electronically directly connected to the mains (e.g. household appliances, power tools, etc.)
- 0 (instruments without measured measurement category): Other circuits that are not connected directly to the mains

### 3.4 Mains Voltage

The instrument applies 50 Hz/60 Hz mains voltages ranging from 115 VAC or 230 VAC (tolerance  $\pm 10\%$ ). Mains voltage switching is not intended. The input line fuse is accessible externally. Power socket and fuse holder form a single unit.

You need to first disconnect the power cord from the connector before you can safely replace the fuse (as long as the fuse holder is undamaged). Next, the fuse holder must be pried out using a screwdriver. The starting point is a slot next to the contacts. The fuse can then be forced out of its mounting and must be replaced with an identical fuse (see information about the fuse type on the rear panel). The fuse holder will be inserted against the spring pressure until it locks into place. The use of mended fuses or short

circuiting the fuse holder is prohibited. Resulting damages are not covered by the warranty.

### NOTICE

#### Safe operation

If the instrument is to remain unattended for a longer time period, it must be switched off at the mains switch for safety reasons.

## 3.5 Limits

The R&S NGE100B is equipped with a protective overload feature. The protective overload feature prevents damage to the instrument and is intended to protect against a possible electrical shock. The maximum values for the instrument must not be exceeded. The protection limits are listed on the front panel of the R&S NGE100B to ensure the safe operation of the instrument.

These protection limits must be adhered to:

Specification	Limits
Maximum output voltage	32 VDC
Maximum output current	3 A (max 33.6 W per channel)
Maximum voltage against earth	250 V peak
Maximum reverse voltage	33 VDC
Maximum inverse voltage	0.4 VDC
Maximum permitted current in case of inverse voltage	3 A
Power supply	115 VAC or 230 VAC (tolerance $\pm 10\%$ )
Frequency	50 Hz/60 Hz
Maximum power output	100 W (R&S NGE103B), 66 W (R&S NGE102B)

## 4 Quick Start

The following chapters under Quick Start are identical to the printed R&S NGE100B Quick Start manual.

- [Putting into Operation](#)..... 13
- [Instrument Tour](#)..... 19
- [Trying Out the Instrument](#)..... 23
- [Maintenance](#).....24

### 4.1 Putting into Operation

This chapter describes the steps to set up the R&S NGE100B for the first time.

---

#### **WARNING**

##### **Risk of injury and instrument damage**

The instrument must be used in an appropriate manner to prevent electric shock, fire, personal injury, or damage.

- Do not open the instrument casing
- Read and observe the "Basic Safety Instructions" delivered as a printed brochure with the instrument. Note that the basic safety instructions also contain information on operating conditions that prevent damage to the instrument

In addition, read and observe the safety instructions in the following sections. Notice that the data sheet may specify additional operating conditions.

---



---

#### **WARNING**

##### **Risk of radio interference**

This instrument is compliant with Class A of CISPR 32. In a residential environment, this instrument may cause radio interference.

---

**NOTICE****Risk of instrument damage during operation**

An unsuitable operating site or test setup can cause damage to the instrument and the connected devices. Ensure the following operating conditions before you switch on the instrument:

- The instrument is dry and shows no sign of condensation
- The instrument is positioned as described in [Chapter 4.1.4.1, "Bench Operation"](#), on page 18
- The ambient temperature does not exceed the range specified in the data sheet
- Signal levels at the input connectors are all within the specified ranges
- Signal outputs are correctly connected and not overloaded

**EMI impact on measurement results**

Electromagnetic interference (EMI) may affect the measurement results.

To suppress the generated EMI:

- Use suitable shielded cables of high quality, for example, LAN cables
- Note the EMC classification in the data sheet

• <a href="#">Safety</a> .....	14
• <a href="#">Intended Operation</a> .....	15
• <a href="#">Unpacking and Checking the Instrument</a> .....	17
• <a href="#">Setting Up the Instrument</a> .....	17

**4.1.1 Safety**

This instrument was built in compliance with DIN EN 61010-1 (VDE 0411 part 1), safety regulations for electrical instruments, control units and laboratory equipment. It has been tested and shipped from the plant in safe condition. It is also in compliance with the regulations of the European standard EN 61010-1 and the international standard IEC 61010-1.

To maintain this condition and ensure safe operation, you must observe all instructions and warnings given in this user manual. Casing, chassis and all measuring ports are connected to a protective earth conductor. The instrument is designed in compliance with the regulations of protection class I.

For safety reasons, the instrument may only be operated with authorized safety sockets. The power cord must be plugged in before signal circuits may be connected.

Never use the product if the power cable is damaged. Check regularly that the power cables are in perfect condition. Choose suitable protective measures and installation types to ensure that the power cord cannot be damaged and that no harm is caused by tripping hazards or from electric shock, for instance.



**⚠ DANGER****Risk of electric shock**

It is prohibited to disconnect the earthed protective connection inside or outside of the instrument!

If it is assumed that a safe operation is no longer possible, the instrument must be shut down and secured against any unintended operation.

Safe operation can no longer be assumed as follows:

- Instrument shows visible damage
- Instrument includes loose parts
- Instrument no longer functions properly
  - After an extended period of storage under unfavorable conditions (e.g. outdoors or in damp rooms)
  - After rough handling during transport (e.g. packaging that does not meet the minimum requirements by post office, railway or forwarding agency)

**⚠ DANGER****Exceeding the Low Voltage Protection**

Use insulated wires and not bare wires for the terminal connection.

For the series connection of all output voltages, it is possible to exceed the low voltage protection of 42 V. Please note that in this case any contact with live components is life-threatening. It is assumed that only qualified and trained personnel service the power supplies and the connected loads.

Prior to switching on the product, it must be ensured that the nominal voltage setting on the product matches the nominal voltage of the AC supply network. If it is necessary to set a different voltage, the power fuse of the product must be changed accordingly.

#### 4.1.2 Intended Operation

The instrument is intended only for use by personnel familiar with the potential risks of measuring electrical quantities.

For safety reasons, the instrument may only be connected to properly installed safety socket outlets. Separating the ground is prohibited.

The power plug must be inserted before signal circuits may be connected.



Use only the power cord included in the delivery package. See "Delivery package" on page 17.

Before each measurement, measuring cables must be inspected for damage and replaced if necessary. Damaged or worn components can damage the instrument or cause injury.

The product may be operated only under the operating conditions and in the positions specified by the manufacturer, without the product's ventilation being obstructed. If the manufacturer's specifications are not observed, this can result in electric shock, fire and/or serious personal injury, and in some cases, death.

Applicable local or national safety regulations and rules for the prevention of accidents must be observed in all work performed.

The instrument is designed for use in the following sectors: Industrial, residential, business and commercial areas and small businesses.

The instrument is designed for indoor use only. Before each measurement, you need to verify at a known source if the instrument functions properly.



To disconnect from the mains, the low-heat device socket on the back panel has to be unplugged.

See [Table 4-1](#) for the general data on the instrument specification. For more information, see the instrument product brochure (PN: 5214.8748.12).

**Table 4-1: General data on instrument specification**

Mains nominal voltage	AC	115/230 V (±10 %) 50/60 Hz
Power consumption	Maximum input power	180 W
Mains fuses	115 V AC	IEC 60127-2/5 T 5 A 250 V
	230 V AC	IEC 60127-2/5 T 2.5 A 250 V
Temperature	Operating temperature range	0 °C to + 40 °C
	Storage temperature range	- 20 °C to + 70 °C
Humidity	Non-condensing	5 % to 80 %
Display		3.5 " (QVGA)
Rack mount capability	½ 19 "	R&S HZC95 option
Dimensions	W x H x D	222 mm x 88 mm x 280 mm (8.74 in x 3.46 in x 11.02 in)
Weight	R&S NGE102B	4.9 kg (10.80 lb)
	R&S NGE103B	5.0 kg (11.02 lb)

### 4.1.3 Unpacking and Checking the Instrument

Check the equipment for completeness using the delivery note and package contents list for the various items. Check the instrument for any damage and loose parts. If there is any damage, immediately contact the carrier who delivered the instrument.



#### Packing material

Retain the original packing material. If the instrument needs to be transported or shipped at a later date, you can use the material to protect the control elements and connectors.

### NOTICE

#### Risk of damage during transportation and shipment

Insufficient protection against mechanical and electrostatic effects during transportation and shipment can damage the instrument.

- Always ensure that sufficient mechanical and electrostatic protection are provided
- When shipping an instrument, the original packaging should be used. If you do not have the original packaging, use sufficient padding to prevent the instrument from moving around inside the box. Pack the instrument in antistatic wrap to protect it from electrostatic charging
- Secure the instrument to prevent any movement and other mechanical effects during transportation

#### Delivery package

The package contents contain the following items:

- R&S NGE100B power supply preloaded with two 230 V fuses
- Four power cables
- Two 115 V fuses (replace the preloaded fuses with these fuses depending on the mains voltage, see [Chapter 4.2.2, "Switching On the Instrument"](#), on page 22 for more information)
- One Getting Started manual
- One document folder containing safety instructions, calibration certificate, KC and CE certificate

### 4.1.4 Setting Up the Instrument

The R&S NGE100B is designed for benchtop and rackmount.

#### 4.1.4.1 Bench Operation

On a benchtop, the R&S NGE100B can either lie flat or stand on its feet. As shown in [Figure 4-1](#), feet on the bottom can be folded out to set the instrument in an inclined position.



Figure 4-1: Operating positions

### NOTICE

#### Positioning of instrument

The instrument must be positioned in a manner that allows the user to disconnect the unit from the mains at any time and without restrictions.

#### 4.1.4.2 Rack Mounting

The instrument can be installed in a 19 " rack-mount using a rack adapter kit.

### NOTICE

#### Ambient temperature

Place the R&S NGE100B in an area where the ambient temperature is within +0 °C to +40 °C. The R&S NGE100B is fan-cooled and must be installed with sufficient space on the top to ensure a free flow of air. Required minimum distance: 1 rack unit (RU).



Figure 4-2: Rack mounting

## 4.2 Instrument Tour

This chapter provides an overview of all the controls available in the R&S NGE100B models and steps to switch on the instrument for the first time.

- [Overview of Controls](#)..... 19
- [Switching On the Instrument](#)..... 22

### 4.2.1 Overview of Controls

#### 4.2.1.1 Front Panel

The front panel of the R&S NGE100B is as shown in [Figure 4-3](#). The function keys and navigation controls are located at the right side of the display. The various connectors are located below the display and function keys.



**Figure 4-3: Front panel of R&S NGE100B**

- 1 = Display
- 2 = Function keys
- 3 = Rotary knob and arrow keys
- 4 = Output channels (three for NGE103B and two for NGE102B)
- 5 = USB connector
- 6 = Power key

#### Display

The display is a color LCD screen. Depending on the instrument type, up to three channels are shown on the screen. The respective measurement settings and functions are displayed in the individual channel section. There is a status bar above the channels to show whether a certain function is enabled, disabled or operating in a certain mode.

For a detailed description on-screen layout, see section "Screen Layout" in the User Manual.

### Function keys

Function keys are means of input for manual operation of the instrument functions. When a function key is pressed, all the related keys are also illuminated.

For detailed description on function keys, see section "Function Keys" in the User Manual.

### Rotary knob and arrow keys

Rotary knob and arrow keys are means of navigation and adjustment. When pressed or rotated, they perform tasks like navigation around the screen, adjustment of parameter values or confirmation of entries.

For detailed description on rotary knob and arrow keys, see section "Navigation Controls" in the User Manual.

### Output channels

Depending on the instrument type, up to three output channels are available for output of power to the connected load. They are Ch 1, Ch 2 and Ch 3 (0 V to 32 V/0 A to 3 A).

### USB connector

The USB connector is a Type-A connector. You can connect a USB flash drive to this connector to perform a firmware update. See section "Firmware Update" in the release notes for the update procedure.

For screenshot and firmware update, USB flash drive file system supports FAT32 only.

### Power key

The **Power** key switches the instrument on and off.

#### 4.2.1.2 Rear Panel

Figure 4-4 shows the rear panel of the R&S NGE100B with its connectors.

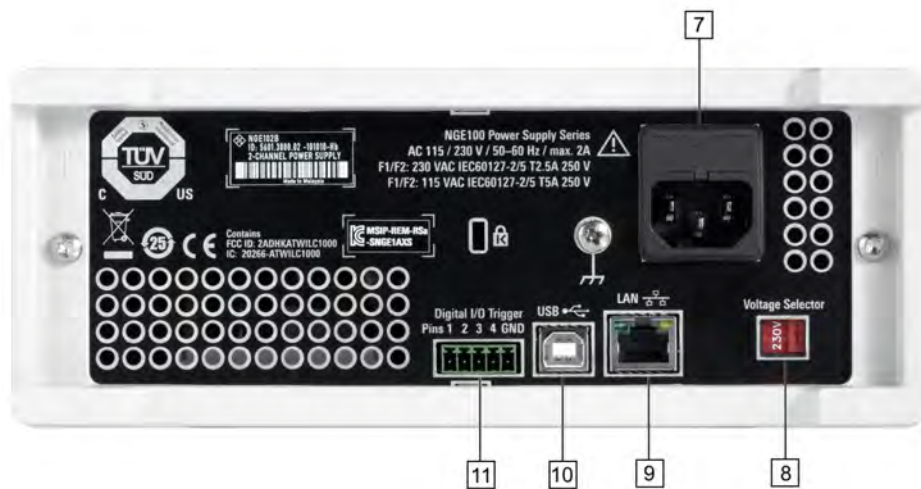

**Figure 4-4: Rear panel of R&S NGE100B**

- 7 = AC inlet with fuse holder
- 8 = Voltage selector
- 9 = Ethernet (LAN) connector
- 10 = USB connector
- 11 = Digital I/O connector

#### AC inlet with fuse holder



#### Main supply cord

Do not use detachable mains supply cord with inadequate rating.

For safety reasons, the instrument can only be operated with authorized safety sockets.

The power cable must be plugged in before signal circuits can be connected. Never use the product if the power cable is damaged. See [Chapter 4.2.2, "Switching On the Instrument"](#), on page 22 for more information.

#### Voltage selector

The voltage selector selects the mains voltage between 115 V and 230 V.

#### Ethernet connector

This connector is used for establishing remote control via SCPI or LXI. See section "Ethernet Setup" in the user manual for more information on the connection setup.

The Ethernet option NGE-K101 must be installed for this function to be available in the instrument.

#### USB connector

The USB connector is a Type-B connector for remote control operation via USB TMC or USB VCP.

### Digital I/O connector

The Digital I/O connector is a terminal block for external trigger input or output.

Measurement control can be achieved by means of an external input signal or using an external output signal to trigger other instruments for some measurements.

The Digital Trigger I/O option (NGE-K103) must be installed for this function to be available in the instrument.

## 4.2.2 Switching On the Instrument

Prior to switching on the instrument, check if the value on the voltage selector corresponds to the mains voltage (115 V or 230 V). Switch it, if necessary, and change the power fuse of the instrument accordingly.

To change the power fuse:

1. Peel off the yellow label sticker on the AC inlet.
2. Pull out the fuse holder which is located directly on top of the socket.
3. Remove the preloaded fuses from the fuse holder.
4. Check the caps of both fuses that you want to change to for their ratings. There should be written either T5A250V for 115 V or T2.5A250V for 230 V. The fuse size is 5 x 20 mm.
5. Once verified, insert the fuses into each groove of the fuse holder.
6. Return the fuse holder to its position in the panel.

### To switch on the instrument:

1. Connect the power cable to the AC inlet and switch on the mains power.
2. Press **Power** key on the front panel.  
The instrument performs a system check, boots the operating system, and starts the R&S NGE100B firmware.  
By default, all output channels are off when the instrument is switched on to prevent connected loads from being damaged unintentionally.  
Instrument settings from memory location M1 and auto saved parameters are loaded during the instrument startup.  
For more information on the store/recall instrument settings, see the "Store and Recall" chapter in the user manual.

To switch off the instrument, press **Power** key again.



## 4.3 Trying Out the Instrument

This chapter describes some basic functions that you can perform with the R&S NGE100B.

### 4.3.1 Selecting the Channels

To select a channel, press the corresponding channel key. The key illuminates.

### 4.3.2 Setting the Output Voltage and Current Limit

To set the output voltage and current limit via Live-Mode:

1. Long press the rotary knob to enter into editing mode.  
The channel 1 voltage is highlighted in blue.
2. Move to the desired parameter via the arrow keys.
3. On the desired parameter, rotate the knob to adjust its value.

Alternatively:

1. Press **Voltage** or **Current** key on the front panel.
2. Press the desired channel key to activate the respective voltage or current limit setting for that channel. The value on the respective channel becomes editable and the digit for adjustment is indicated by a blue cursor.
3. Press the right or left arrow key to move the cursor.
4. Press the up/down arrow key or turn the rotary knob to change the value of the digit indicated by the cursor. The new value registers immediately.

### 4.3.3 Activating the Channels Output

The output voltages can be switched on or off irregardless of the operating mode the instrument is in.

To activate the channel output, press **Output** key on the front panel followed by the desired channel key or vice versa. The font color of that channel section changes to green or red depending on the operating mode the instrument is in.

### 4.3.4 Storing/Recalling of Instrument Settings

The instrument settings can be stored in the instrument memory by long pressing **Store Recall** key and selecting the memory location key (**M1** to **M5**). The previous setting is overwritten.

To retrieve the desired saved settings, press **Store Recall** key and select the memory location key (**M1** to **M5**).

## 4.4 Maintenance

Before cleaning the instrument, ensure that it has been switched off and power cable is disconnected.

Clean the outer case of the instrument at regular intervals, using a soft, lint-free dust cloth.

---

### **NOTICE**

#### **Instrument damage caused by cleaning agents**

Cleaning agents contain substances that may damage the instrument. For example, cleaning agents that contain a solvent may damage the front panel labeling, plastic parts, or the display.

Never use cleaning agents such as solvents (thinners, acetone, etc.), acids, bases, or other substances.

---

The display may only be cleaned with an appropriate glass cleaner. Rub the display down with a dry, clean and lint-free cloth. Do not allow cleaning fluid to enter the instrument.

## 5 Instrument Functions

The following chapters describe the operating procedures of the R&S NGE100B user interface and functions.

### 5.1 User Interface

This chapter describes how you can interact with R&S NGE100B via the various keys, menus and navigation controls in the instrument.

#### 5.1.1 Screen Layout



Figure 5-1: Screen layout for 3-channel or 2-channel instrument

#### Status bar

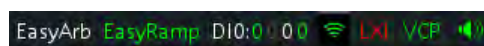



Table 5-1: Status bar function

Function	Description
EasyArb	Arbitrary output sequences on Ch 1.
EasyRamp	Output voltage to ramp continuously within a 10 ms to 10 s until set voltage, $V_{set}$ .
DIO:xxxx	Digital Trigger I/O (Digital Trigger I/O option NGE-K103 must be installed). The "xxxx" refers to I/O status for DIO1, DIO2, DIO3, DIO4.
	Wireless LAN connection (WLAN option R&S NGE-K102 must be installed).
LXI	Wired LAN connection with LXI service for remote control operation (Ethernet option R&S NGE-K101 must be installed).

Function	Description
TMC/VCP	USB connection with USB-VCP or USB-TMC setting.
	Indicate buzzer state (Disabled, Fault Events, Any Events).

The status bar shows the state of some of the instrument functions. The state can be enabled, disabled, switched on, switched off or operating in a certain mode. The state is indicated by the icon color.

**Table 5-2: Summary of function status**

Function	State	Font color
EasyArb	Disabled	Grey
	Enabled	White
	In use	Green
EasyRamp	Disabled	Grey
	In use for any channel	Green
DIO	Disabled or option NGE-K103 uninstalled	Grey
	Enabled	White
	In use	Green
WLAN	Disconnected or disabled or option NGE-K102 uninstalled	Grey
	Connecting to access point	Yellow
	Connected to access point	Green
LXI	LAN/LXI fault or option NGE-K101 uninstalled	Red
	LAN/LXI in operation	Green
USB	TMC connection selected	Green
	VCP connection selected	Green
Speaker	Disabled	Grey
	Enabled	Green

### Channel display area

Three channels are shown on the channel display area for NGE103B, and two for the NGE102B. The respective channel settings and functions are displayed in the individual channel.



Figure 5-2: Channel display area for 3-channel and 2-channel instrument

Table 5-3: Available parameters in the channel display area

Parameter	Description
Channel	Display channel number.
Power	Display output power in Watt.
Voltage	Voltage in Volt. The display resolution for voltage is two digits after the decimal point.
Current	Current limit in Ampere. The display resolution for current is three digits after the decimal point.
Fuse	Indicator to show the fuse status (on or off). When triggered, the indicator shows flashing and displays in red.
OVP/OPP/OTP	Indicator to show that the overload voltage or current protection is triggered. When triggered, the indicator shows flashing and displays in red.
Channel history information	Only available in a 2-channel instrument. It records and displays the historical maximum and minimum channel information (P min, P max, V min, V max, I min, I max).

Different font colors on the screen are used to differentiate the various output status and operating condition of the instrument. It is easy to know and confirm the different output status and operating conditions of the instrument by looking at the colors.



Figure 5-3: Color coding of operating condition

Color	Operating mode	Description
□	Inactive mode	Display only.
■	Editing mode	A solid blue background is shown when an item is selected.
■	CV mode	Active outputs are operated in a constant voltage mode. See <a href="#">Chapter 5.3, "Output Modes"</a> , on page 34.
■	CC mode	Active outputs are operated in a constant current mode. See <a href="#">Chapter 5.3, "Output Modes"</a> , on page 34.

## 5.1.2 Function Keys

The keys can be categorized based on their functions.



- 1 = [Memory functions](#)
- 2 = [Output settings and functions](#)
- 3 = [Navigation keys](#)

### Memory functions

These keys are dedicated for a specific preprogrammed function.

Function keys	Description
M1 to M5	Five memory keys to save or recall instrument settings.
Store Recall	Saves/loads instrument settings. See <a href="#">Chapter 5.4.5, "Store and Recall"</a> , on page 38.

### Instrument functions

These keys control the channel output settings and instrument functions.

Function keys	Description
Ch 1 Ch 2 Ch 3	Selects the respective channel for settings. See <a href="#">Chapter 5.4.1, "Setting the Channels Voltage and Current"</a> , on page 35.
Output	Toggles the output of the selected channel on or off. See <a href="#">Chapter 4.3.3, "Activating the Channels Output"</a> , on page 23.

Function keys	Description
<b>Voltage</b>	Sets the output voltage for the channel. See <a href="#">"Set output voltage and current"</a> on page 35.
<b>Current</b>	Sets the output current limit for the channel. See <a href="#">"Set output voltage and current"</a> on page 35.
<b>Track</b>	Configures the tracking function. See <a href="#">Chapter 5.4.2, "Tracking Function"</a> , on page 36.
<b>Menu</b>	Main menu of the instrument. See <a href="#">Chapter 5.1.5, "Menu"</a> , on page 32. Long press on <b>Menu</b> key to capture screenshot on the USB stick. The default screenshot filename starts with a prefix <code>nge100_scr_</code> followed by an ascending index 000-999 (e.g. <code>nge100_scr_001.bmp</code> ).
<b>Remote</b>	Long press on <b>Remote</b> key to switch from remote to local control mode.
<b>Fuse</b>	Toggles the fuse on/off. See <a href="#">Chapter 5.5.2, "Fuse"</a> , on page 42.

### Navigation keys

These keys provide navigation control in the instrument.

Function keys	Description
<b>Enter</b>	Confirms menu selection or entry in dialog boxes. Start and stop (long press) the EasyArb function. See <a href="#">Chapter 5.5.3, "EasyArb"</a> , on page 43.
<b>Back</b> 	Returns to the previous menu level or exit the menu mode. In the menu dialog, press the <b>Back</b> key to discard changes and restore the previous value. In the channel display area, press the <b>Back</b> key to exit editing mode and keep the changes made. In a 2 channel instrument, long press on <b>Back</b> key also reset the channel history information. See <a href="#">Table 5-3</a>





### 5.1.3 Virtual Keyboard

The virtual keyboard is an on-screen keyboard to input symbols and alphanumeric characters in the input field. It can be invoked wherever there is an input field.



Figure 5-4: Virtual keyboard

Invoke the virtual keyboard as follows:

1. Move the cursor to the desired input field.
2. Press **Enter** key. The virtual keyboard appears.
3. Once on the keyboard screen, press the arrow keys or turn the rotary knob to go to the desired character.
4. Press the rotary knob to select the character.  
 Select  key if you want to create a space between characters.  
 To delete the last entered character, select the  key.  
 To delete the current entry, select the  key.  
 Select the  key to alternate between capital and small capital letters.
5. Repeat step 3 and 4 until all the characters are entered.
6. Select "OK" to confirm the input and exit the screen.  
 Select "ESC" or press **Menu** key to exit the screen without saving the changes.

### 5.1.4 Navigation Controls

Navigation and value setting are done via the rotary knob and arrow keys.

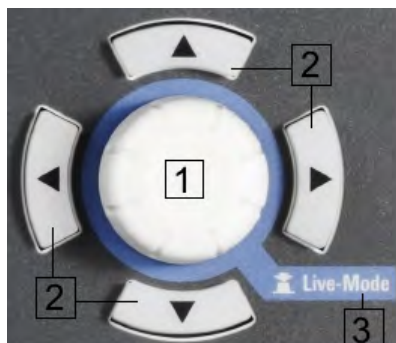

Figure 5-5: Navigation control



- 1 = Rotary Knob
- 2 = Arrow keys
- 3 = Live-mode

#### 5.1.4.1 Rotary Knob



Step size changes of the numeric value correspond to the speed of the rotary knob.

The rotary knob has several functions depending on the mode it is in.

- Increments (clockwise direction) or decrements (counter-clockwise direction) any kind of numeric value when in editing mode.
- Navigates down (clockwise direction) or up (counterclock-wise direction) the menu or menu items when rotated.
- Acts as an **Enter** key when pressed.
- Enter editing mode when pressed.
- Enter [Live-mode](#) when long pressed.

#### 5.1.4.2 Arrow Keys

Using arrow keys, you can do several things:

- The up and down keys increase or decrease any kind of numeric value when in editing mode.
- Navigate through the menu or menu items in the dialog box.
- Long press on the up and down keys increase or decrease the numeric value of the menu items to the maximum or minimum value when in editing mode. To stop the increasing or decreasing of value, press the rotary knob.
- The left and right keys move the cursor in an input field in the corresponding direction.

#### 5.1.4.3 Live-Mode

When the instrument goes into the Live-mode, all the arrow keys are illuminated.

The instrument automatically sets the Ch 1 voltage to editing mode. See [Figure 5-3](#). You can navigate to other channel settings by using the arrow keys to edit the voltage and current values.

The duration of Live-mode depends on the [General Instrument Settings](#). Set a longer fallback time if you need more time in this mode.

To exit Live-mode, press the rotary knob.

### 5.1.5 Menu

The R&S NGE100B menu provides access to the instrument's advanced functions and some general settings. You can also obtain the instrument and service information via the menu.

To access this mode:

1. Press **Menu** key on the front panel. The main menu screen appears.

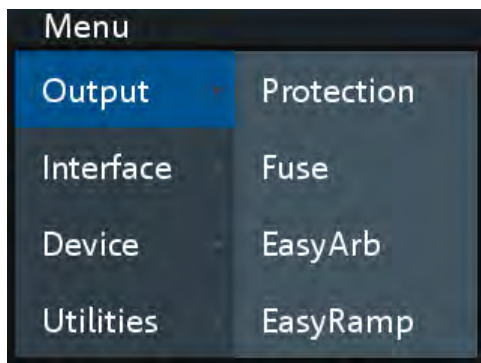

Figure 5-6: Main menu

2. Navigate the menu via the rotary knob or arrow keys.
3. Press the rotary knob or **Enter** key to enter into the submenu.
4. Press  key to return to the previous menu level or exit the menu mode if it is already at the main menu level. Alternatively, press **Menu** key to exit the menu mode from any menu level.

Table 5-4: Main menu hierarchy

Menu	Descriptions
Output	Menu items related to the instrument's advanced output functions.
Interface	Menu items related to connection setup.
Device	Menu items related to the instrument's general settings, reset function and information about the instrument.
Utilities	Menu items such as system test, firmware update function and information for service.

Table 5-5: Output menu hierarchy

Menu	Menu items	Descriptions
Output	Protection	Configures the OVP and OPP protection settings for the instrument. See <a href="#">Chapter 5.5.1, "Protection"</a> , on page 40.
	Fuse	Configures the fuse delay and fuse linking function of the channel. See <a href="#">Chapter 5.5.2, "Fuse"</a> , on page 42.

Menu	Menu items	Descriptions
	EasyArb	Programs the waveform of the instrument voltage and current settings for Ch 1. See <a href="#">Chapter 5.5.3, "EasyArb"</a> , on page 43.
	EasyRamp	Configures the ramping time of the voltage for selected channel. See <a href="#">Chapter 5.5.4, "EasyRamp"</a> , on page 44.

**Table 5-6: Interface menu hierarchy**

Menu	Menu items	Descriptions
Interface	Ethernet	Configures the Ethernet interface. See <a href="#">Figure 5-20</a> . The Ethernet option NGE-K101 must be installed for this function to be available in the instrument.
	WLAN	Configures the WLAN interface. See <a href="#">Figure 5-21</a> . The WLAN option NGE-K102 must be installed for this function to be available in the instrument.
	Digital IO	Configures the Digital Trigger I/O settings. The Digital Trigger I/O option NGE-K103 must be installed for this function to be available in the instrument.
	USB	Configures the USB connection. See <a href="#">Figure 5-23</a> . Requires restart of the instrument to apply the setting.

**Table 5-7: Device menu hierarchy**

Menu	Menu items	Descriptions
Device	Information	Displays instrument information. See <a href="#">Chapter 5.7.1, "Instrument Information"</a> , on page 52.
	General	Configures general instrument settings. <a href="#">Chapter 5.7.2, "General Instrument Settings"</a> , on page 53.
	License	Displays license information and install license options. See <a href="#">Chapter 5.7.3, "Managing Options"</a> , on page 54.
	Reset	Resets instrument to factory default settings. See <a href="#">Chapter 5.7.4, "Reset Instrument"</a> , on page 55.

**Table 5-8: Utilities menu hierarchy**

Menu	Menu items	Descriptions
Utilities	System Test	Provides self-test function for display screen, keypad backlight, beeper and fan. See <a href="#">Chapter 5.7.5, "System Test"</a> , on page 55.
	Update	Performs firmware update on the instrument. See <a href="#">Chapter 5.7.6, "Updating the Firmware"</a> , on page 56.
	Service	This function is restricted for service personnel only.
	Help	Provides help information for the instrument. See <a href="#">Chapter 5.7.7, "Help"</a> , on page 57.

## 5.2 Power Derating

The NGE103B includes three identical channels with a continuous voltage range of 0 to 32 V. The instrument provides a source of up to 3 A at 11.2 V and at 32 V, it provides up to 1.05 A using the sophisticated power management.

Similar to NGE103B, the NGE102B provides an output power of 33.6 W for Ch 1 and Ch 2 respectively.

Combination of the set voltage and current limit results in the following output performance graph.

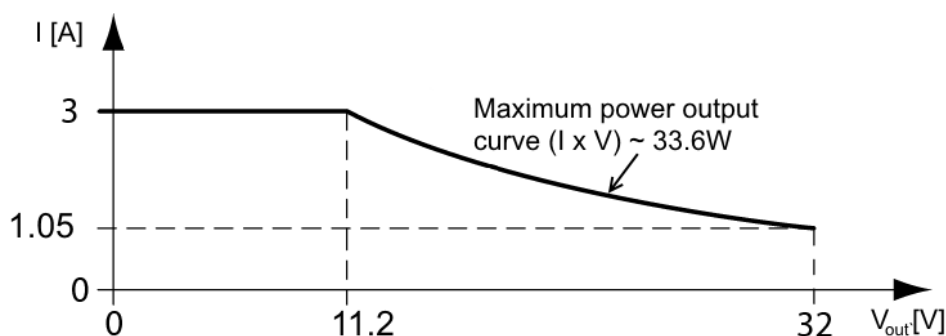

Figure 5-7: Output performance graph

According to the electrical basis formula for power ( $P$ ) = current ( $I$ ) x voltage ( $V$ ), the following results for the maximum power per channel:

- NGE102B: 33.6 W per channel (67 W max for the combination of two channels)
- NGE103B: 33.6 W per channel (100 W max for the combination of three channels)

For more information on the combination of channels, see [Chapter 7.1, "Parallel and Serial Mode"](#), on page 98.

## 5.3 Output Modes

The R&S NGE100B includes two operating modes, i.e. the constant voltage (CV) and constant current (CC). The instrument switches automatically between CV and CC depending on the connected load.

### CV mode

[Figure 5-8](#) shows that in the range of voltage regulation, the output voltage  $V_{out}$  remains constant while the current may increase to its maximum value  $I_{max}$  when the connected load is increasing. In CV mode, the font text in the channel display area changes to green.

See [Figure 5-3](#).

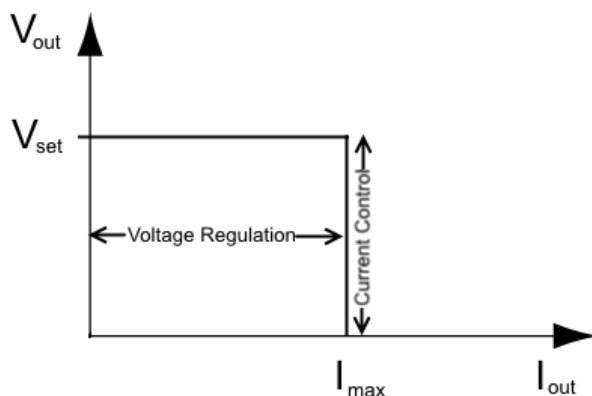

Figure 5-8: Current limit

### CC mode

The current  $I_{\max}$  corresponds to the current setting adjustable in the instrument.

If  $I_{\text{out}}$  reaches  $I_{\max}$ , the instrument switches to CC mode, i.e. the output current remains constant and limited to  $I_{\max}$  even if the load increases. Instead, the output voltage  $V_{\text{out}}$  decreases to almost zero with a short circuit. In CC mode, the font text in the channel display area changes to red.

See [Figure 5-3](#).

## 5.4 Basic Functions

### 5.4.1 Setting the Channels Voltage and Current

NGE103B comes with three channels and NGE102B comes with two channels.

Toggle the respective channel key (**Ch 1**, **Ch 2** or **Ch 3**) on the front panel to select these channels. When a channel is selected, the respective channel key illuminates. See [Figure 5-9](#).

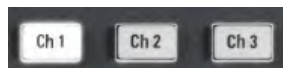

Figure 5-9: Ch 1 key illuminates when selected

#### Set output voltage and current

The R&S NGE100B adjust voltage values between 0 V to 32.2 V with a step size of 0.01 V and current values between 0.003 A to 3.025 A with a step size of 0.001 A.

The setting of current value corresponds to the  $I_{\max}$  of the respective channel. It is advisable to set the current limit prior to operating the instrument to prevent damage to the load and instrument in the case of malfunction like short-circuit.

1. Press **Voltage** or **Current** key.  
The previous set channel will be selected.  
The channel font changes to blue and all the navigation controls illuminate.  
Selected **Voltage** or **Current** key and the channel key are also illuminated.
2. Press the desired channel key to switch to that channel.  
Selected channel key (**Ch 1**, **Ch 2**, **Ch 3**) illuminates.
3. Enter the desired voltage or current value.
4. Press the rotary knob, **Voltage/Current** or **Enter** key to confirm the value.  
The selected channel font text changes to yellow.



Figure 5-10: Voltage and current settings in the instrument

See [Chapter 5.1.4.3, "Live-Mode"](#), on page 31 for alternative way to configure the voltage and current values.

See also [General Instrument Settings](#) on the keypad for setting the fallback time.

## 5.4.2 Tracking Function

For power supplies with multiple channels, the channels can be linked such that changes made on one channel are applied to the tracked channel.

For example, the channel 1 output supplies 6 V, intended for digital logic. The other two supplies 20 V, which can be used with bipolar analog circuitry. The tracking adjustments are applied to the two 20 V supplies so that the + and - 20 V supplies can be adjusted together.

1. Press **Track** key.  
The R&S NGE100B activates the tracking function and the **Track** key illuminates.  
Previous selected channel and **Voltage** keys are also illuminated.
2. Press the tracked channels.  
The selected tracked channel keys (**Ch 1**, **Ch 2**, **Ch 3**) illuminate.

3. Press **Current** key if current values should be tracked.  
The selected channels are highlighted in blue and all the navigation controls illuminate.  
Selected **Voltage** or **Current** key is also illuminated.
4. Set the desired voltage or current value.  
Use the arrow keys of rotary knob to enter the value. All tracked channels voltage or current are changed by the same amount.



### 5.4.3 Activating Fuse

To protect a connected, sensitive output in general, the R&S NGE100B power supply includes an electronic fuse which can be switched on individually for each channel.

To switch on the fuse for each channel, first ensure that the output is turned off.

1. Press **Fuse** key.  
The R&S NGE100B activates the fuse function.  
**Fuse** key illuminates.  
Activated fuses are illuminated on channel keys.
2. Press the desired channel to activate or deactivate the fuse.  
Selected channel key (**Ch 1**, **Ch 2**, **Ch 3**) illuminates.  
On the channel display area, the word "FUSE" appears for the selected channel.
3. Repeat step 1 and step 2 to disable the fuse function.



Figure 5-11: Fuse switched on for the respective channel

A delay can be applied to every channel fuse. Also, individual electronic fuses (Fuse-Link) can be logically linked so as to switch off the interlinked channels.

For more information, see [Fuse](#) for the fuse delay and FuseLink configuration.

#### 5.4.4 Activating the Channels Output

The outputs of all the channels (**Ch 1**, **Ch 2**, **Ch 3**) can be switched on or off by toggling the **Output** key on the front panel.

By default, the output is switched off when the instrument is switched on. The output is also automatically switched off when no channel is selected. This design prevents a connected load from being damaged unintentionally.

1. Press the desired channels.  
Selected channel keys (**Ch 1**, **Ch 2**, **Ch 3**) illuminate.
2. Press **Output** key.  
The R&S NGE100B output the set voltage of the selected channel.  
Depending on the output mode, the font text in the channel display area shows green when in CV mode and red when in CC mode.  
See [Chapter 5.3, "Output Modes"](#), on page 34.



Figure 5-12: Output of Ch 3 in CV and CC mode

Multiple outputs can be switched on at the same time. See more information in [Chapter 7.1, "Parallel and Serial Mode"](#), on page 98.

See also [Power Derating](#).

#### 5.4.5 Store and Recall



Upon power-up, the instrument loads the stored setting from memory location M1 with the exception on EasyArb parameters. Auto saved parameters are also applied during startup.

The R&S NGE100B output state of all channels (Ch 1, Ch 2, Ch 3) are disabled when the recall function is activated.





### Auto save instrument settings

Auto save of instrument settings are applied when any of the following parameters are changed:

- [General instrument settings](#)
- [USB connection mode](#)
- [WLAN settings](#)
  - "Module"
  - "SSID"
  - "Password"
- Ethernet

The instrument settings can be stored or recalled from memory locations M1 to M5.

The following instrument settings are stored or recalled in the memory location:

- [Fuse settings](#)
- [Protection settings](#)
- [EasyRamp settings](#)
- Set voltage level
- Set current level
- <sup>1</sup>[EasyArb settings](#)
- <sup>1</sup>[Digital IO settings](#)

<sup>1</sup>The EasyArb or DIO settings can only be saved in the respective dialog environment and all other above instrument settings are not saved when a store function is made.

When a recall function is made on the same stored memory location, only the EasyArb or DIO settings are recalled.

### Store instrument settings

1. Long press **Store Recall** key to store instrument settings.  
The R&S NGE100B displays a message in the status bar "Store device settings: select any [Mx] key".



2. Press any of the memory keys (**M1**, **M2**, **M3**, **M4**, **M5**) to store the instrument settings.  
The R&S NGE100B stores the instruments settings in the selected memory location.

### Recall instrument settings

1. Press **Store Recall** key to recall instrument settings.  
The R&S NGE100B displays a message in the status bar "Recall device settings: select any [Mx] key".

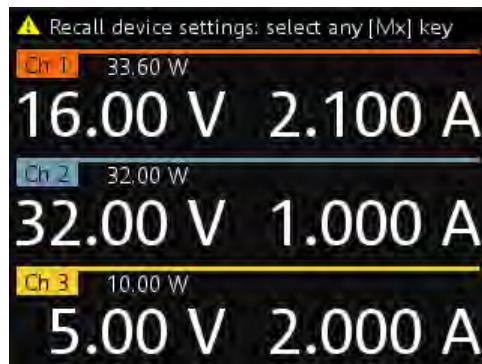

2. Press any of the memory keys (**M1**, **M2**, **M3**, **M4**, **M5**) to recall the instrument settings.  
The R&S NGE100B recalls the instruments settings from the selected memory location.

## 5.5 Advanced Functions

The following chapters provide information about the menu items found in the **Menu** key.

1. Press **Menu** key.  
The R&S NGE100B displays the main menu of the instrument.  
See [Chapter 5.1.5, "Menu"](#), on page 32.
2. Select the desired menu item.  
The R&S NGE100B displays the respective menu item dialog.

### 5.5.1 Protection

The R&S NGE100B provides individual overvoltage protection (OVP) and overpower protection (OPP) settings for each channel. With both function activated, the R&S NGE100B protects itself and the load in case of voltage or power overloads.

When protection is tripped, a red flashing OVP or OPP indicator displays on the respective channel. See [Figure 5-13](#).

A beep is sounded if buzzer is enabled. See [Figure 5-25](#).



Figure 5-13: Indicator of OVP/OPP when tripped

1. Select "Output > Protection" menu item.  
The R&S NGE100B displays the "Protection" dialog. See [Figure 5-14](#).

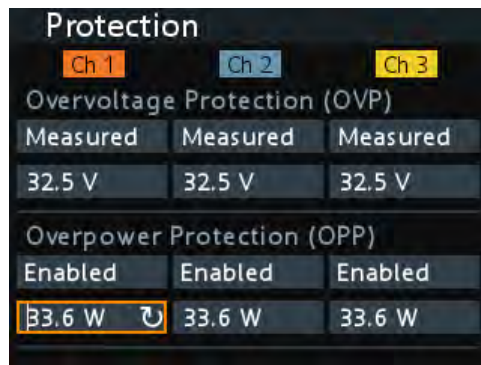

Figure 5-14: Protection dialog

2. Set the OVP mode for the desired channel.  
The available options are as follows:
  - "Measured": The output is switched off if the measured value exceeds the set limit. Switching on the channels triggered the OVP if the condition remains.
  - "Protected": The output is disabled if the setting exceeds the set limit.
  - "Disabled": OVP is set to maximum value supported by hardware. See the R&S NGE100B brochure for the instrument specification.
3. Set the desired voltage for OVP.  
You can set a value from 0 V to 32.5 V.  
The R&S NGE100B turns off the respective channel when the measured voltage exceeded the preset value.
4. Set the OPP mode for the desired channel.  
The available options are as follows:
  - "Enabled": The channel is turned off if the measured power exceeds OPP value.
  - "Disabled": Output power is limited to maximum value of 33.6W.

- Set the desired voltage for OPP.  
You can set a value from 0 W to 33.6 W.  
The R&S NGE100B turns off the respective channel when the measured power exceeded the preset value.

## 5.5.2 Fuse

Fuse delay and fuse linking functions provide the flexibility to handle a fuse tripped event when it occurs. When a fuse tripped event triggered, the affected channels are turned off according to the settings configured in the fuse delay and fuse linking.

The fuse delay function is intended to ignore the current peaks set above the current limit that occur during the time set in the fuse delay. This prevents the fuse to be triggered in case of a capacitive load.

With fuse linking function, it allows you to logically interlink channels with their electronic fuses. During operation, if the fuse trips, all channels interlinked with this channel will be turned off. See [Chapter 5.4.3, "Activating Fuse"](#), on page 37 for more information.

The fuse is activated via the **Fuse** key on the front panel. See [Chapter 5.1.2, "Function Keys"](#), on page 28

- Select "Output > Fuse" menu item.  
The R&S NGE100B displays the "Fuse" dialog. See [Figure 5-15](#).

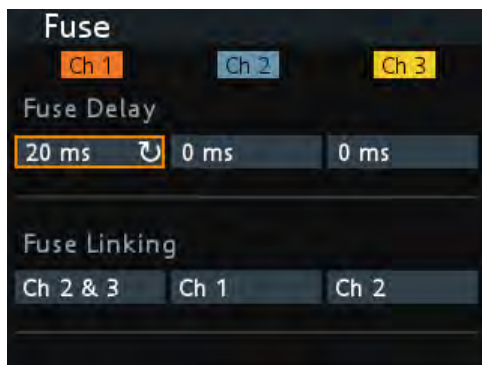

*Figure 5-15: Fuse dialog*

- Set "Fuse Delay" to a desired value.  
You can set a value from 0 ms to 10 s in a 10 ms step size.
- Configure the "Fuse Linking" setting.  
The R&S NGE100B provides the following options:  
Example for channel 1, the available options are as follows:
  - "Ch 2": Ch 2 is linked to Ch 1. If Ch 1 fuse tripped, Ch 2 will be turned off.
  - "Ch 3": Ch 3 is linked to Ch 1. If Ch 1 fuse tripped, Ch 3 will be turned off.
  - "Ch 2 & 3": Ch 2 and Ch 3 are linked to Ch 1. If Ch 1 fuse tripped, Ch 2 and Ch 3 will be turned off.

- "Disabled": Ch 1 is not linked to any other channels.

### 5.5.3 EasyArb



#### EasyArb function

The arbitrary function is available only in Ch 1.

The R&S NGE100B series allows you to generate freely programmable waveforms which can be reproduced within the limits set by the instrument for voltage and current.

1. Select "Output > EasyArb" menu item.  
The R&S NGE100B displays the "EasyArb" dialog. See [Figure 5-16](#).

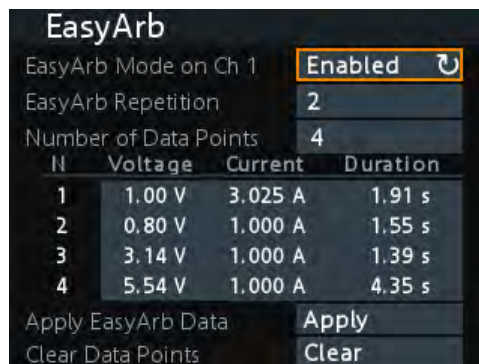

*Figure 5-16: EasyArb dialog*

2. Set "EasyArb Mode" to "Enabled".  
The R&S NGE100B enabled the EasyArb function for Ch 1.  
Note: If "EasyArb Mode" is set disabled, corresponding output state of Ch 1 is also disabled.
3. Set the desired data points for the EasyArb function.  
The R&S NGE100B displays the number of EasyArb entry points in the EasyArb table.
4. Set the desired repetition cycle for the EasyArb function
5. Configure the EasyArb table with the desired values for voltage, current and duration.
6. Press "Apply" to save the EasyArb settings.  
The EasyArb data points are sent to Ch 1.
7. Press "Clear" to reset the EasyArb table values.  
All the EasyArb data points are clear from Ch 1.  
See [Table 5-9](#).
8. Press **Menu** key to return to the [Channel display area](#).

The **Enter** key is illuminated.

9. Press **Output** key to enable R&S NGE100B output.
10. Press **Enter** key to start the EasyArb function.
11. Long press on the **Enter** key to stop the EasyArb function.

**Table 5-9: EasyAab input field**

EasyArb input field	Description
EasyArb Mode	Enable or disable the EasyArb function. If enabled, the EasyArb function is activated in Ch 1. See "EasyArb function" on page 43.
Data Points	Set the number of data points in the EasyArb table. Each data point contains the settings for "Voltage", "Current" and "Duration".
Repetition	Set the number of times the waveform is output in the EasyArb table. If this is set to "0", the waveform is output continuously.
EasyArb table	Configures the EasyArb data table. Use the arrow keys to navigate the "Voltage", "Current" and "Duration" settings.
Clear	Reset all the data points in the EasyArb table to 0.00 V, 1.000 A and 0.01 s for "Voltage", "Current" and "Duration" respectively.
Apply	Select "Apply" to save EasyArb configuration.

### 5.5.4 EasyRamp

With EasyRamp, the R&S NGE100B provides you the operating condition to output a constant rise of the supply voltage. The output voltage can be increased continuously within a 10 ms to 10 s timeframe. See [Figure 5-17](#).

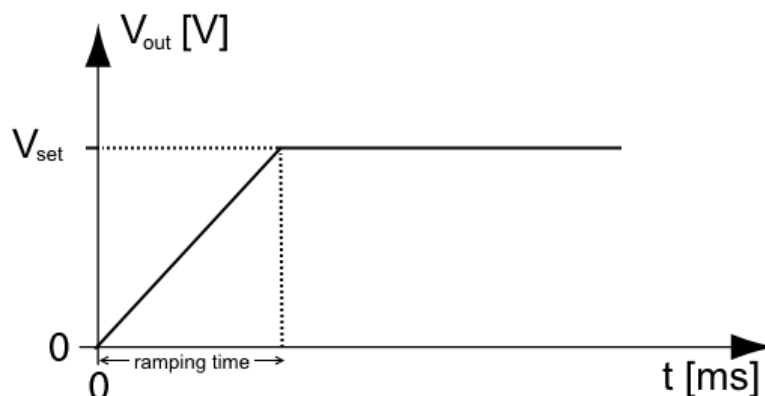

**Figure 5-17: Ramping voltage output**

1. Select "Output > EasyRamp" menu item.  
The R&S NGE100B displays the "EasyRamp" dialog. See [Figure 5-18](#).

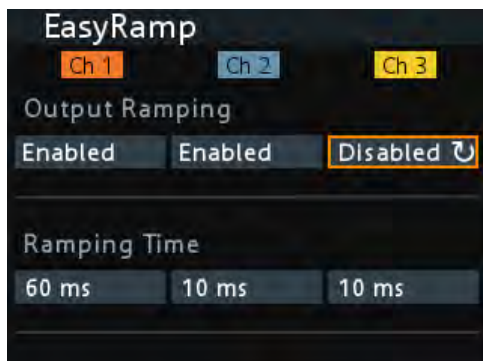

Figure 5-18: EasyRamp dialog

2. Select the desired channel.
3. Set the selected channel to "Enabled".  
The R&S NGE100B enabled the EasyRamp function for the selected channel.  
Note: If selected channel is set disabled, corresponding output state of the selected channel is also disabled.
4. Set the "Ramping Time" of the selected channel.
5. Press **Enter** key to confirm the settings.

Table 5-10: EasyRamp input field

EasyRamp input field	Description
Ch 1, Ch 2, Ch 3	Enable or disable the EasyRamp function individually for each channel.
Ramping Time	Duration taken for the voltage to rise to $V_{set}$

### 5.5.5 Digital Trigger I/O

#### **CAUTION**

##### Digital I/O Pins Voltage Rating

Do not exceed the maximum voltage rating of the Digital I/O pins (5.25 V max) when supplying voltages to the pins.



R&S NGE-K103 (order number: 5601.2227.03) option is required for the Digital Trigger I/O.

The four data lines of the digital I/O interface are mutually independent and can be used as trigger input or trigger output separately. See [Figure 4-4](#).

- **Trigger input**  
The data lines of the digital I/O interface receive external trigger signal. The external trigger signal triggers the selected channel (Ch 1, Ch 2, Ch 3) with the set response when the trigger condition (Active High or Active Low) is met.
- **Trigger output**  
The data lines of the digital I/O interface output an "Active Low" or "Active High" signal when the trigger condition of the selected channel (Ch 1, Ch 2, Ch 3) is met.

**Table 5-11: Trigger in parameters and conditions**

Trigger in parameters	Trigger conditions		Description
Channel	Ch 1, Ch 2, Ch 3		Target output channel selected for trigger response.
Response Trigger	Output On	Level	Selected channel <b>Output</b> is enabled when the selected logic level is met.
	Output Off	Level	Selected channel <b>Output</b> is disabled when the selected logic level is met.
	Output Toggle	Pulse	Selected channel <b>Output</b> is toggled when the selected logic pulse is met.
	Output Inhibit	Level	Selected channel <b>Output</b> is inhibited when the selected logic level is met.  When the selected channel <b>Output</b> is put to inhibit state, manual or remote operation on selected channel <b>Output</b> is no longer possible .  To reverse the inhibit state, remove the source of the trigger signal. You can either disable the affected DIO interface or remove the source from the affected DIO interface at the rear panel.
	Start EasyArb (Only for Ch 1)	Level	Activates the EasyArb function on channel 1 when the selected logic level is met. The EasyArb is deactivated when the level changes (i.e from active high to active low) See <a href="#">Chapter 5.5.3, "EasyArb"</a> , on page 43.
Pulse		Activates the EasyArb function on channel 1 when the selected pulse is met. See <a href="#">Chapter 5.5.3, "EasyArb"</a> , on page 43.	
Logic	Active High		Set the logic level of the trigger in signal.
	Active Low		

**Table 5-12: Trigger out parameters and conditions**

Trigger out parameters	Trigger conditions		Description
Channel	Ch 1, Ch 2, Ch 3		Output channel selected to monitor for trigger condition.
Condition Trigger	Output On		Output the selected logic level when the <b>Output</b> is turned on at the selected channel.



Trigger out parameters	Trigger conditions		Description
	Output Off		Output the selected logic level when the <b>Output</b> is turned off at the selected channel.
	Fuse Tripped		Output the selected logic level when a fuse tripped event occurs on the selected channel. See <a href="#">Chapter 5.4.3, "Activating Fuse"</a> , on page 37 and <a href="#">Chapter 5.5.2, "Fuse"</a> , on page 42.
	CC Mode		Output the selected logic level when the selected channel operates in the CC mode. See <a href="#">"CC mode"</a> on page 35.
	Voltage Level	>= "set value"	Output the selected logic level when the voltage level of the selected channel is greater or equal to the set level.
	Current Level	>= "set value"	Output the selected logic level when the current level of the selected channel is greater or equal to the set level.
	Critical Event	OVP	Output the selected logic level when the selected critical event (OVP, OPP, OTP) occurs on the selected channel. See <a href="#">Chapter 5.5.1, "Protection"</a> , on page 40.
		OPP	
		OTP	
	EasyArb Active		Output the selected logic level when the EasyArb function is running on channel 1. See <a href="#">Chapter 5.5.3, "EasyArb"</a> , on page 43.  Note: For a reliable DIO trigger output, the EasyArb waveform needs to be at least 200 ms.
Logic	Active High		Set the logic level of the trigger out signal.
	Active Low		

- Select "Interface > Digital IO" menu item.  
The R&S NGE100B displays the "Digital IO" dialog. See [Figure 5-19](#).

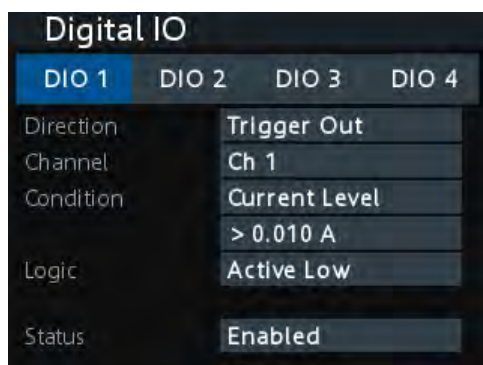

Figure 5-19: Digital IO dialog

- Select the desired DIO interface.

3. Select "Trigger In" to accept external trigger signal or "Trigger Out" to output the trigger signal.
4. Set the desired channel.
5. Select the desired trigger condition.  
See [Table 5-11](#) and [Table 5-12](#).
6. Set the desired "Logic" state.
7. Set the status to "Enabled".  
The R&S NGE100B enabled the selected DIO interface and monitor or feedback the trigger condition onto the selected channel.

## 5.6 Connecting to a Network

### 5.6.1 LAN Connection



R&S NGE-K101 (order number: 5601.2204.03) option is required to connect the R&S NGE100B to a network via LAN connection.

There are two methods to establish a local area network (LAN) connection with the R&S NGE100B for remote control operation.

#### 5.6.1.1 Wired Connection

The network card can be operated with a 10 Mbps Ethernet IEEE 802.3 or a 100 Mbps Ethernet IEEE 802.3u interface.

#### **NOTICE**

##### **Risk of network failure**

Before connecting the instrument to the network or configuring the network, consult your network administrator. Errors may affect the entire network.



To establish a network connection, connect a commercial RJ-45 cable to the LAN port of the instrument and to a PC.

Depending on the network capacities, the TCP/IP address information for the instrument can be obtained in different ways.

- If the network supports dynamic TCP/IP configuration using the Dynamic Host Configuration Protocol (DHCP), and a DHCP server is available, all address information can be assigned automatically.
- Otherwise, the address must be set manually. Automatic Private IP Addressing (APIPA) is not supported.

By default, the instrument is configured to use dynamic TCP/IP configuration and obtain all address information automatically. This means that it is safe to establish a physical connection to the LAN without any previous instrument configuration.

## NOTICE

### Risk of network errors

Connection errors can affect the entire network. If your network does not support DHCP, or if you choose to disable dynamic TCP/IP configuration, you must assign valid address information before connecting the instrument to the LAN. Contact your network administrator to obtain a valid IP address.

1. Connect a LAN cable to the LAN port (see [Figure 4-4](#) for the location of the LAN port).
2. Configure the connection settings manually or have the network configure the settings for you via menu. By default, automatic configuration is set in the instrument. For manual configuration, configure the settings as follows:
  - a) Select "Interface > Ethernet" menu item.  
The R&S NGE100B displays the "Ethernet" dialog. See [Figure 5-20](#).



Figure 5-20: Ethernet dialog

- b) Select "DHCP & Auto-IP" for "IP Mode".
- c) Enter the "IP Address".
- d) Enter the "Subnet Mask".
- e) Enter the "Default Gateway".
- f) Select "Apply" to complete the configuration.
- g) Press **Menu** key to exit the dialog.

When the connection is alive, the LXI icon turns green on the status bar.

**Table 5-13: Ethernet input field**

Ethernet input field	Description
MAC Address	Shows the MAC address of this instrument.
Status	Shows if the connection is up or down.
IP Mode	Static & Manual: Manually configure an IP address for the instrument. DHCP & Auto-IP: Automatically assign an IP address to the instrument.
IP Address	Address used in communication with the network. Manually configure this field if IP Mode set to "Static & Manual".
Subnet Mask	Secondary address used in communication with the network. Manually configure this field if IP Mode set to "Static & Manual".
Default Gateway	Gateway address to connect to the network. Manually configure this field if IP Mode set to "Static & Manual".
LAN Reset	Restores the LAN settings to factory default. It also removes the LXI web password.
Apply	Apply static IP settings.

### 5.6.1.2 Wireless Connection



R&S NGE-K102 (order number: 5601.2210.03) option is required to connect the R&S NGE100B to a network via WLAN connection.



#### WLAN connection

The LAN connection has a higher priority over WLAN.

If LAN is connected, the WLAN connection will be disconnected. When LAN is disconnected, WLAN will reconnect automatically.

1. Select "Interface > WLAN" menu item.  
The R&S NGE100B displays the "WLAN" dialog. See [Figure 5-21](#).

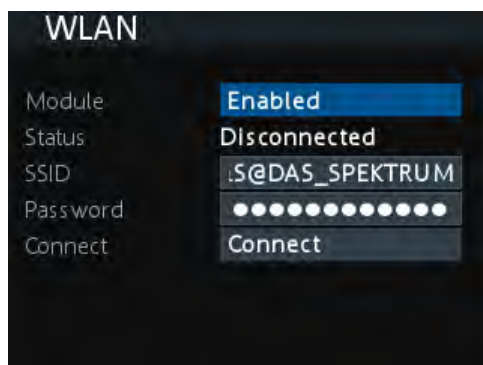

Figure 5-21: WLAN dialog

2. Select "Enabled" for "Module".
3. Set the "SSID"  
SSID - Service Set Identifier, an unique ID used for naming wireless network.
4. Set the associated password for the "SSID".
5. Select the "Connect" button.  
If connection is successful, the "Status" shows "Connected". See [Figure 5-22](#).  
When the connection is alive, the WLAN icon turns green on the status bar. See [Figure 5-1](#).

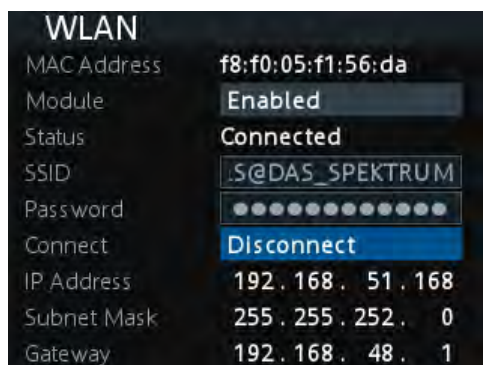

Figure 5-22: WLAN connected

6. To disconnect, select "Disconnect" in the WLAN dialog.

## 5.6.2 USB Connection

Alternatively, connect a USB cable to the USB port (see [Figure 4-4](#) for the location of the USB port and PC for a USB connection). The R&S NGE100B supports USB TMC and USB VCP connection.

For more information, see [Chapter 6.1.1, "USB"](#), on page 59.

1. Select "Interface > USB" menu item.  
The R&S NGE100B displays the "USB" dialog. See [Figure 5-23](#).

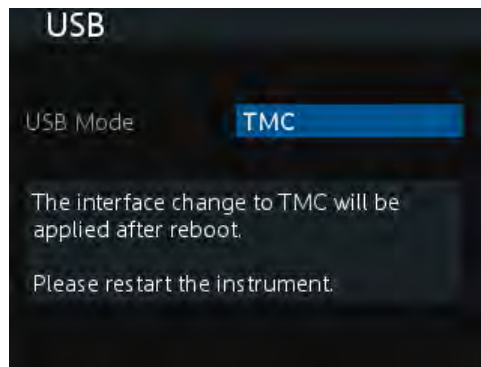

Figure 5-23: USB dialog

2. Set the desired "USB Mode".
3. Press **Enter** key to confirm the settings.  
The R&S NGE100B displays message to prompt the user to restart the instrument to apply the changes.
4. Restart the R&S NGE100B to apply changes.

## 5.7 General Instrument Settings

The following chapters provide the general instrument information and utilities services in R&S NGE100B.

### 5.7.1 Instrument Information

The "Information" dialog provides the general instrument information of R&S NGE100B.

- ▶ Select "Device > Information" menu item.  
The R&S NGE100B displays the "Information" dialog. See [Figure 5-24](#).

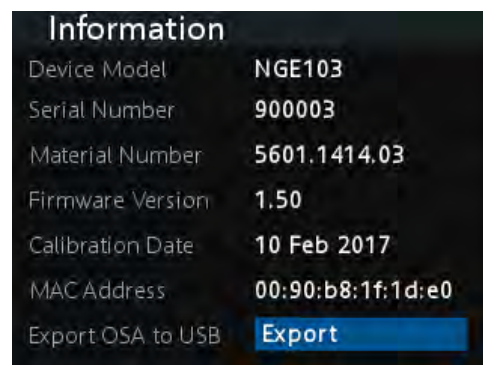

Figure 5-24: Information dialog

Device information	Description
Device Model	Model of the instrument, i.e. NGE102B or NGE103B.
Serial Number	Unique identification number for the instrument.
Material Number	Instrument orderable part number.
Firmware Version	Software version that is installed in the instrument.
Calibration Date	The last registered date when calibration was carried out on the instrument.
Mac Address	Mac address of the network interface.
Export OSA to USB	The Open Source Acknowledgment (OSA) of the R&S NGE100B can be exported to USB stick for reference.

## 5.7.2 General Instrument Settings

General instrument settings such as keypad fallback time, screen display brightness and buzzer setting are provided.

- ▶ Select "Device > General" menu item.  
The R&S NGE100B displays the "General" dialog. See [Figure 5-25](#).



*Figure 5-25: General dialog*

General instrument settings	Description
Keypad	Selects the wait time before the instrument automatically leaves the editing mode. Select "Off" to disable the automatic switching back.
Display	Selects the specific screen intensity to control the screen brightness. Setting is applied immediately.
Sound	Selects the event where sound is generated. <ul style="list-style-type: none"> <li>• Fault Events: Sounds on faulty events only</li> <li>• Any Event: Sounds on faulty events and key press events</li> <li>• Disabled: No sound is generated</li> </ul>

### 5.7.3 Managing Options

Options are enabled by entering a registered license key code.

You may choose to install from an xml file on USB or by manually entering the key code.

- Select "Device > License" menu item.

The R&S NGE100B displays the "License" dialog. See [Figure 5-26](#).



Figure 5-26: License dialog

To install from an xml file, proceed as follows:

1. Copy the xml file containing the registered key code into the USB flash drive.
2. Connect the USB flash drive to the USB port of the instrument.
3. Select "Install".  
If the installation is successful, the option is marked as "Installed" under Installation Status.

To manually enter the key code, proceed as follows:

1. Press **Enter** key to invoke the [Virtual Keyboard](#).
2. Enter the key code (30-digit number) of the option in the entry box.



3. Select "Install".  
If the correct key code is entered, the option is marked as "Installed".  
If an invalid key code is entered, an error message is displayed. Re-enter the correct key code.

### 5.7.4 Reset Instrument

This function resets the instrument to factory default settings.

- ▶ Select "Device > Reset" menu item.  
The R&S NGE100B displays the "General" dialog. See [Figure 5-27](#).

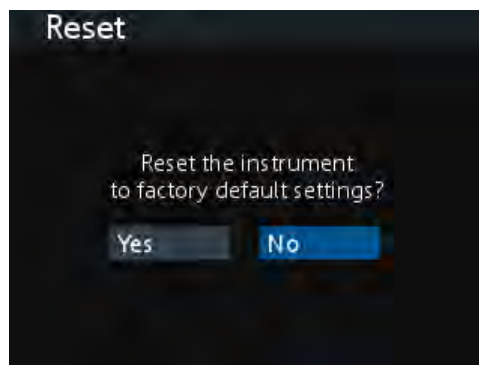

Figure 5-27: Reset dialog

### 5.7.5 System Test

This function provides a system test to check the instrument working conditions for screen color display, key backlight, beeper and cooling fan.

- ▶ Select "Utilities > System Test" menu item.  
The R&S NGE100B displays the "System Test" dialog. See [Figure 5-28](#).



Figure 5-28: System test dialog

System Test	Description
Screen Test	Test that the display is working. RGB and a list of supported colors should appear on the screen during the test.
Key Backlight Test	Test that the key backlight is working. All the keys on the front panel except the softkeys ( <b>M1</b> , <b>M2</b> , <b>M3</b> , <b>M4</b> , <b>M5</b> ) and <b>Store Recall</b> key should illuminate during the test.
Beeper Test	Test that the instrument sound is working. Three beep sounds should be heard during the test.
Fan Test	Test that the cooling fan is working.

### 5.7.6 Updating the Firmware

The latest firmware file can be found from the product homepage <http://www.rohde-schwarz.com/product/nge100b>.

For firmware update using SCPI command, see "[Firmware update via SCPI command for version 1.3 and above](#)" on page 57.



Do not power off or operate the instrument during a firmware update.

Do not rename the firmware filename `NGE100FWRelease.tar.gz.enc` and `NGE100FWRelease.fwp`.

1. Download the firmware file from the product homepage.
2. Unzip the firmware to the root directory of a USB flash drive.  
There are two files after the unzip, do not rename these files.
3. Connect the USB flash drive to the USB port of the instrument and wait for ten seconds.
4. Press **Menu** key.  
The R&S NGE100B displays the main menu of the instrument. See [Chapter 5.1.5, "Menu"](#), on page 32.
5. Select "Utilities > Update" menu item.  
If firmware file is found, the R&S NGE100B displays the "Update" dialog. See [Figure 5-29](#).

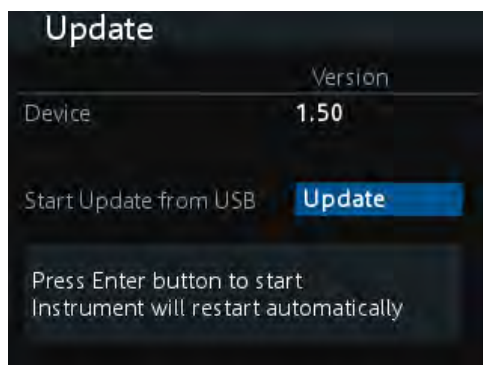

Figure 5-29: Update dialog

6. Press **Enter** key to start firmware update process.  
The R&S NGE100B reboots automatically as part of the update process.
7. Press **Enter** key to confirm the update when prompt.
8. Alternatively, you can press **Back** key to cancel the firmware update process.
9. Wait for the completion of the update process.  
It takes a few minutes to complete the firmware update process.

#### Firmware update via SCPI command for version 1.3 and above

1. Download the firmware file from the product homepage.
2. Unzip the firmware to the root directory of a USB flash drive.  
There are two files after the unzip, do not rename these files.
3. Connect the USB flash drive to the USB port of the instrument and wait for ten seconds.
4. Connect to the instrument via USB, LAN or WLAN. See [Chapter 5.6.1.1, "Wired Connection"](#), on page 48 and [Chapter 5.6.2, "USB Connection"](#), on page 51.
5. Send `DIAGnostic:SERVICE:FWUP "NGE100FWRelease.tar.gz.enc"` to start firmware update remotely.  
The R&S NGE100B reboots automatically as part of the update process.
6. Wait for the completion of the update process.  
It takes a few minutes to complete the firmware update process.

### 5.7.7 Help

The "Help" dialog provides the internet link and QR code for the latest R&S NGE100B information.

1. Select "Utilities > Help" menu item.  
The R&S NGE100B displays the "Help" dialog. See [Figure 5-30](#).



*Figure 5-30: Help dialog*

2. Use a QR code reader to scan the QR code to link to the online product home page.  
Alternatively, you could enter the address: <http://www.rohde-schwarz.com/product/nge100b> into a browser to access the latest help information.

## 6 Remote Control

This chapter provides information on operating an instrument via remote control.

### 6.1 Interfaces and Protocols

R&S NGE100B can be remotely controlled via the following interfaces:

- USB
- LAN  
Available only if option R&S NGE-K101 is installed.
- WLAN  
Available only if option R&S NGE-K102 is installed.

#### 6.1.1 USB

The R&S NGE100B includes a USB device port. See [Chapter 5.6.2, "USB Connection"](#), on page 51.

##### 6.1.1.1 USB VCP



The following requirements for USB-VCP driver installation are necessary:

- A PC with operating system Windows XP, VISTA, Windows 7 or Windows 8 (32Bit or 64Bit).
  - Administrator rights are necessary for the installation of the driver.
- 

The USB virtual COM port (USB-VCP) is a software interface that allows the communication to the R&S NGE100B using any terminal program (e.g. HMExplorer) via SCPI commands once the corresponding Windows drivers have been installed. The actual USB-VCP driver and software HMExplorer can be downloaded for free from the product homepage (<http://www.rohde-schwarz.com/product/nge100b>).

If a connection between PC and the instrument has been established and no NGE100 USB-VCP driver is installed, the PC operating system displays a "Found New Hardware" wizard. In this case, the NGE100 USB-VCP driver must be installed.

The HMExplorer window application provides the R&S NGE100B a terminal function and also the option to create screenshots and editor function to create the EasyArb table.

For more information of the driver installation and HMExplorer window application, see the installation guide of the driver file and the internal HMExplorer help.

### 6.1.1.2 USB TMC

The USB Test & Measurement class (USB-TMC) is a protocol that allows GPIB-like communication via USB interfaces and is a separate instrument class of the USB specification. The USB-TMC protocol supports service queries, triggers, and other GPIB-specific instructions.

VISA drivers are installed and that it can be used directly in the corresponding environments. The driver is included in the NI-VISA package and can be downloaded at <http://www.ni.com/downloads/ni-drivers/>.

A major benefit of the USB TMC class is that by sampling specific registers the controlling software can determine if commands have been terminated and if they have been processed correctly. With USB-TCP, communication with instrument requires analysis and polling mechanisms within the controlling software which may significantly strain the interface of the measurement instruments. The TMC status registers solve this problem with the USB TMC in the same manner as in the case with the GPIB interface for the hardware via the corresponding control lines.



#### HMExplorer

The window application supports the communication via LAN, USB VCP and WLAN only.

---

For more information of the VISA driver installation, see the installation guide of the VISA driver file.

Once the driver is installed, the "USB Test and Measurement Device (IVI)" is displayed in the Windows Device Manager dialog, see [Figure 6-1](#).

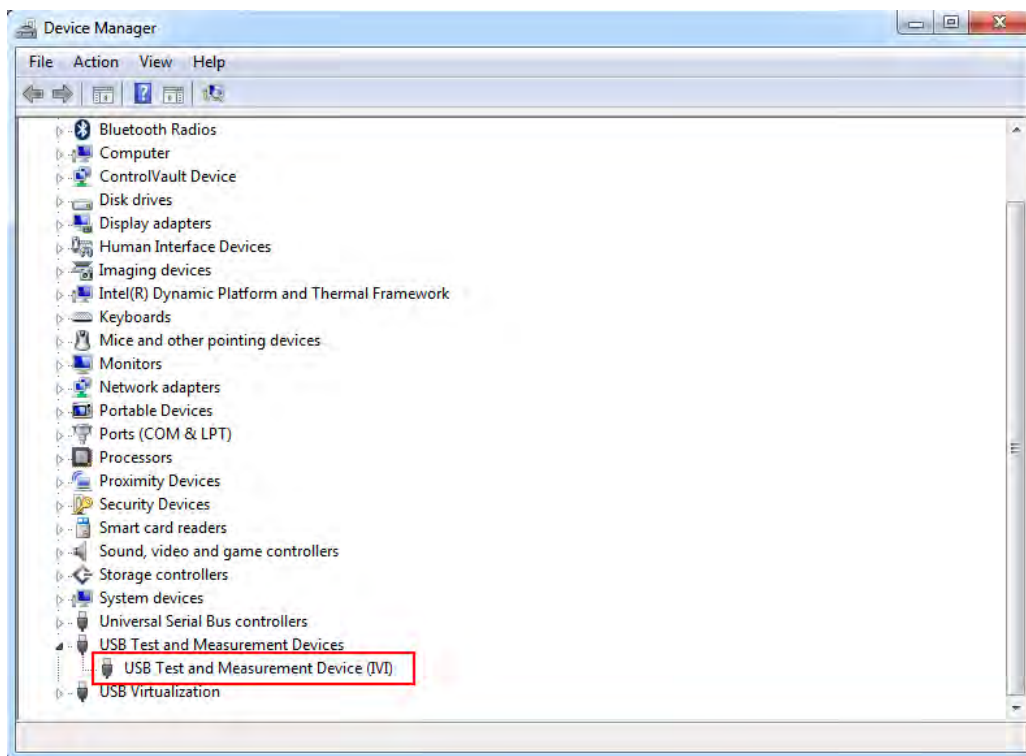

Figure 6-1: Device manager

### 6.1.2 LAN

For direct connection to a host (PC) or indirect connection via a switch, a double shielded network cable (e.g. CAT.5, CAT.5e, CAT.5 +, CAT.6 or CAT.7) is required and equipped with an Ethernet plug type (RJ-45 type connector) on both sides. As a network cable, either an uncrossed or a cross-over cable can be used.

It is possible to perform a complete parameter setting via the manual assignment of a fixed IP address or automatic assignment of a dynamic IP address allocation. Please contact your IT administrator to make the correct settings.

For more information on the LAN settings, see [Chapter 5.6.1.1, "Wired Connection"](#), on page 48.

### 6.1.3 WLAN



#### Wi-Fi Transmitter Performance

Frequency range: 2412 MHz to 2484 MHz

Power: 19.5 dBm typical

Equipped with option R&S NGE-K102, the R&S NGE100B provides an alternative to remote control the instrument via the web. With the presence of an authenticated WLAN signal, the instrument automatically connects to a network and navigation can be made via the web browser according to the WLAN IEEE 802.11 b/g/n standards. See [Figure 6-2](#).

For more information on the WLAN settings, see [Chapter 5.6.1.2, "Wireless Connection"](#), on page 50.

#### 6.1.4 LXI

LAN extension for Instrumentation (LXI) is a platform for measuring devices and test systems based on standard Ethernet technology. LXI is to be the LAN-based successor to GPIB and combine the advantages of Ethernet with the simple and familiar features of the GPIB. This standard provides a new standard for network configuration of front panel devices via a WEB interface. The central tool for this type of configuration is a browser.

LXI-compatible devices are divided into three classes, A, B and C, where the functionality of the classes is based on each other hierarchically:

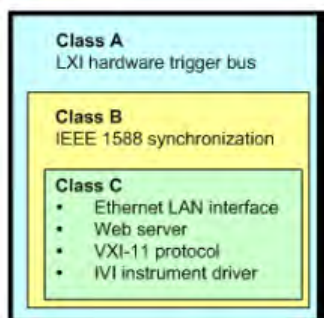

- Class C devices are characterized by a uniform LAN implementation including an ICMP ping responder for diagnostic purposes. Devices can be configured with a WEB browser. A LAN Configuration Initialize (LCI) mechanism resets the LAN configuration. Class C LXI devices are also intended to support automatic detection in a LAN via VXI-11 discovery protocol and programming using IVI drivers.
- Class B adds the IEEE 1588 Precision Time Protocol (PTP) and peer-to-peer communication to base class C. With IEEE 1588, all devices within a network can automatically synchronize to the most accurate available clock, and then provide time-stamps or synchronization signals for all devices with exceptional accuracy.
- Class A devices also contain the eight-channel hardware trigger bus (LVDS interface) according to the LXI standard.

Class A and B devices can send and receive software triggers through LAN messages and communicate with each other without using the controller.

The power supplies of the R&S NGE100B series meet the general requirements of the LXI Class C and correspond to the version 1.5 (LXI Core 2016). Advanced features are not supported.



A key component of an LXI certification is the IVI device driver (Interchangeable Virtual Instrument). Here IVI.NET drivers are provided, which are based on the .NET framework 4 of Microsoft. LabView and LabWindows/CVI drivers built on LabWindows/CVI 2012 are also available. The latest copy of the IVI.NET driver is available for download from the product homepage <http://www.rohde-schwarz.com/product/nge100b>.

In addition to the features described above, the device provides the following LXI-related functions:

- Displays the current device settings
- Remote control of the device within the WEB-Browser

The Ethernet interface has an integrated web server, you can access the instrument with its corresponding IP address in the address line of the browser (i.e. <http://172.25.57.65>). See [Figure 6-2](#).

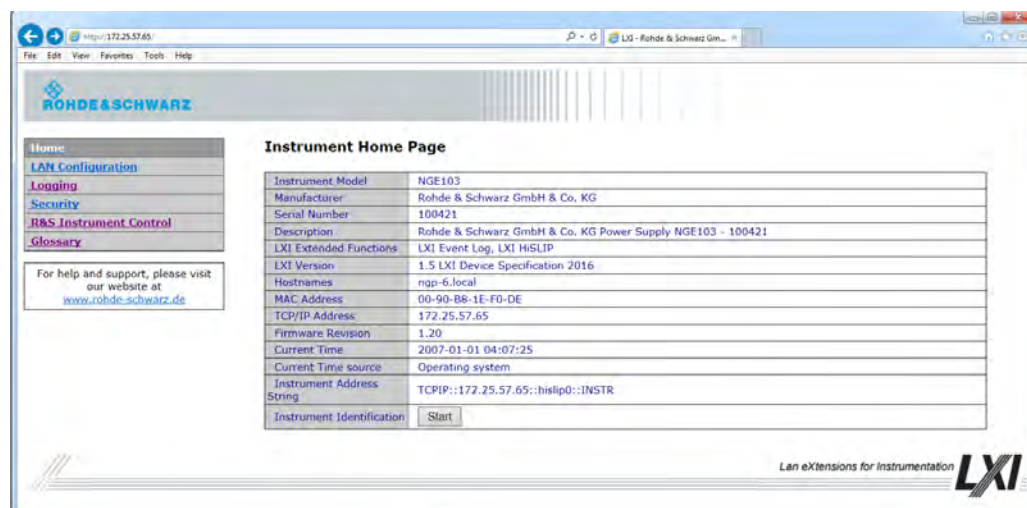

Figure 6-2: Instrument web browser view

### 6.1.5 SCPI

SCPI (Standard Commands for Programmable Instruments) commands - messages - are used for remote control. Commands that are not taken from the SCPI standard follow the SCPI syntax rules. The instrument supports the SCPI version 1999. The SCPI standard is based on standard IEEE 488.2 and aims at the standardization of device-specific commands, error handling and the status registers. The tutorial "Automatic Measurement Control - A tutorial on SCPI and IEEE 488.2" from John M. Pieper (R&S order number 0002.3536.00) offers detailed information on concepts and definitions of SCPI.

The requirements that the SCPI standard places on command syntax, error handling and configuration of the status registers are explained in detail in the following sections. Tables provide a fast overview of the bit assignment in the status registers. The tables are supplemented by a comprehensive description of the status registers.

### 6.1.6 VISA

VISA is a standardized software interface library providing input and output functions to communicate with instruments. The I/O channel (LAN or USB) is selected at initialization time by means of a channel-specific resource string. For more information about VISA, refer to its user documentation.

## 6.2 Setting Up Remote Control Connection

### USB

The following shows the resource string format used when setting up a remote connection via the USB interface:

- **USB TMC**  
`USB0::0x0AAD::0x0197::5601.1414<device_variant>-<device_serial_number>::INSTR` where k03 is used for 3-ch device, k02 for 2-ch device. (e.g. `USB0::0x0AAD::0x0197::5601.1414k03-100689::INSTR`)
- **USB VCP**  
`ASRL<COM>::INSTR`, where "COM" refers to the COM port number shown on the controlling PC. (e.g. `ASRL15::INSTR`)

### LAN/WLAN

Refer to [Chapter 5.6, "Connecting to a Network"](#), on page 48 for configuring the LAN and WLAN parameters.

To set up the connection the IP address of the instrument is required. It is part of the resource string used by the program to identify and control the instrument. The resource string has the form:

```
TCPIP::<IP_address>::INST
```

Example: If the instrument has the IP address 192.1.2.3; the valid resource string is:

```
TCPIP::192.1.2.3::INST
```

High-Speed LAN Instrument Protocol (HiSLIP) is a TCP/IP-based protocol for remote instrument control of LAN-based test and measurement instruments. It was specified by the IVI Foundation and is intended to replace the older VXI-11 protocol. To start remote control session with HiSLIP, the valid resource string is:

```
TCPIP::192.1.2.3::HISLIP
```



The end character must be set to line feed (LF).

## Remote

Press **Remote** to unlock the instrument from the remote control mode. In thithe remotes mode, all front panel keys on the instrument are disable and the **Remote** is illuminated. To switch back to the Local mode, press **Remote** to release the remote control mode.

## 6.3 SCPI Command Structure and Syntax

SCPI describes a standard command set for programming instruments, irrespective of the type of instrument or manufacturer. The goal of the SCPI consortium is to standardize the device-specific commands to a large extent. For this purpose, a model was developed which defines the same functions inside a device or for different devices. Command systems were generated which are assigned to these functions. Thus it is possible to address the same functions with identical commands. The command systems are of a hierarchical structure.

SCPI is based on standard IEEE 488.2, i.e. it uses the same syntactic basic elements as well as the common commands defined in this standard. Part of the syntax of the device responses is defined with greater restrictions than in standard IEEE 488.2 (see [Chapter 6.3.4, "Responses to Queries"](#), on page 72).



### Remote command examples

Not all commands used in the following examples are implemented in the instrument.

• <a href="#">Structure of a Command</a> .....	65
• <a href="#">Parameters</a> .....	70
• <a href="#">Structure of a Program Message</a> .....	72
• <a href="#">Responses to Queries</a> .....	72

### 6.3.1 Structure of a Command

The commands consist of a so-called header and, in most cases, one or more parameters. Header and parameter are separated by a "white space" (ASCII code 0 to 9, 11 to 32 decimal, e.g. blank). The headers may consist of several key words. Queries are formed by directly appending a question mark to the header.

• <a href="#">Common Commands</a> .....	65
• <a href="#">Device-Specific Commands</a> .....	66
• <a href="#">Overview of Syntax Elements</a> .....	69

#### 6.3.1.1 Common Commands

Common commands consist of a header preceded by an asterisk "\*" and one or several parameters, if any.

**Table 6-1: List of supported common commands**

Mnemonic	Name & 488.2 Section
*IDN?	Identification Query 10.14
*OPC	Operation Complete Command 10.18
*OPC?	Operation Complete Query 10.19
*RST	Reset Command 10.32
*TST?	Self-Test Query 10.38
*WAI	Wait-to-Continue Command 10.39

### 6.3.1.2 Device-Specific Commands

- [Hierarchy](#).....66
- [Multiple keywords](#).....67
- [Optional Keywords](#).....67
- [Long and Short Form](#).....68
- [Parameter](#).....68
- [Special Characters](#).....68
- [Numeric Suffix](#).....69

#### Hierarchy

Device-specific commands are of hierarchical structure. The different levels are represented by combined headers. Headers of the highest level (root level) have only one key word. This key word denotes a complete command system.

#### Example:

SOURce

This key word denotes the SOURce command system.

For commands of lower levels, the complete path has to be specified, starting on the left with the highest level, the individual key words being separated by a colon ":".

#### Example:

SOURce:VOLTage:PROTection:LEVel 30

This command lies in the fourth level of the SOURce system. It sets the Overvoltage Protection (OVP) level.

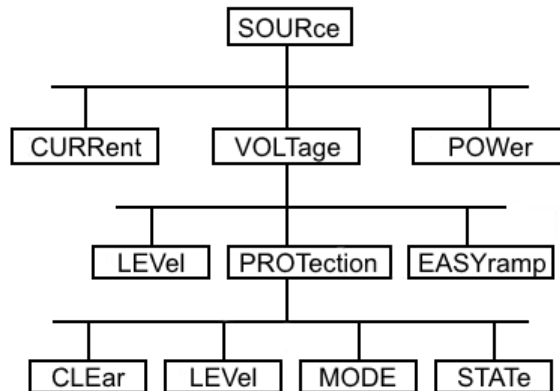

Figure 6-3: Tree structure the SCPI command systems using the SOURce system as example

### Multiple keywords

Some key words occur in several levels within one command system. Their effect depends on the structure of the command, i.e. at which position in the header of a command they are inserted.

#### Example:

```
SYSTEM:COMMunicate:WLAN:[ :STATe]
```

This command contains key word `STATe` in the fourth command level. It enables or disables the wireless.

#### Example:

```
SYSTEM:COMMunicate:WLAN:DHCP[ :STATe]
```

This command contains key word `STATe` in the fifth command level. It defines the status of DHCP.

### Optional Keywords

Some command systems permit certain key words to be inserted into the header or omitted. These key words are marked by square brackets in the description. The full command length must be recognized by the instrument for reasons of compatibility with the SCPI standard. Some commands are considerably shortened by these optional key words.

#### Example:

```
[SOURce]:POWer:PROTection[ :STATe]
```

This command activates or deactivates the Overpower Protection (OPP) for the previous selected channel. The following command has the same effect:

```
POWer:PROTection
```



### Optional keywords with numeric suffixes

Do not omit an optional keyword if it includes a numeric suffix that is relevant for the effect of the command.

### Long and Short Form

The key words feature a long form and a short form. Either the short form or the long form can be entered, other abbreviations are not permitted.

#### Example:

```
STATus:QUEStionable:ENABle 1
```

is equivalent to

```
STAT:QUES:ENAB 1
```



### Upper and lower case notation of commands

Upper-case and lower-case notation only serves to distinguish the two forms in the manual, the instrument itself does not distinguish upper-case and lower-case letters.

### Parameter

The parameter must be separated from the header by a "white space". If several parameters are specified in a command, they are separated by a comma ",". A few queries permit the parameters MINimum, MAXimum and DEFault to be entered. Refer to [Chapter 6.3.2, "Parameters"](#), on page 70 for a detailed description of the various parameters.

#### Example:

```
FUSE:DELAy? MAX
```

Response: 250 ms

The query requests the fuse delay time for the previous selected channel.

### Special Characters

- **Vertical stroke |**  
A vertical stroke in parameter definitions indicates alternative possibilities in the sense of "or". The effect of the command differs, depending on which parameter is used.
- **Square Brackets [ ]**  
Key words in square brackets can be omitted when composing the header. The full command length must be accepted by the instrument for reasons of compatibility with the SCPI standards.

#### Example

```
– [SOURce]:POWer:PROTection[:STATe]?
```

is equivalent to

```
POW:PROT?
```

Parameters in square brackets can be incorporated optionally in the command or omitted as well

- **Braces { }**

Parameters in curly brackets are optional and can be inserted once or several times, or omitted.

Example

- `APPlY {<voltage> | MIN | MAX} [, {<current> | MIN | MAX}]`

The following are valid commands:

```
APPlY
APPlY 6
APPlY 6,2
```

### Numeric Suffix

If a device features several functions or features of the same kind, e.g. inputs, the desired function can be selected by a suffix added to the command. Entries without suffix are interpreted like entries with the suffix 1. Optional keywords must be specified if they select a function with the suffix.



### Suffix counting

In case of remote control, suffix counting may differ from the numbers of the corresponding selection used in manual operation. SCPI prescribes that suffix counting starts with 1. Suffix 1 is the default state and used when no specific suffix is specified.

Some standards define a fixed numbering, starting with 0. With GSM, for instance, slots are counted from 0 to 7. In the case of remote control, the slots are selected with the suffixes 1 to 8. If the numbering differs in manual operation and remote control, it is indicated with the respective command.

#### 6.3.1.3 Overview of Syntax Elements

The following table offers an overview of the syntax elements.

Syntax Element	Description
:	The colon separates the key words of a command. In a program message, the separating semicolon marks the uppermost command level.
;	The semicolon separates two commands within a program message. It does not alter the path.
,	The comma separates several parameters of a command.
?	The question mark forms a query.
*	The asterisk marks a common command.
"	Quotation marks introduce a string and terminate it.

Syntax Element	Description
#	The hash symbol # introduces binary, octal, hexadecimal and block data. <ul style="list-style-type: none"> <li>• Binary: #B10110</li> <li>• Octal: #O7612</li> <li>• Hex: #HF3A7</li> </ul>
" "	A "white space" (ASCII-Code 0 to 9, 11 to 32 decimal, e.g. blank) separates header and parameter.

### 6.3.2 Parameters

For most commands, a parameter needs to be supplemented. The parameter has to be separated from the header by a "white space".

The type of parameter required for each command and the allowed range of values are specified in the command description.

• <a href="#">Numeric Values</a> .....	70
• <a href="#">Special Numeric Values</a> .....	70
• <a href="#">Boolean Parameters</a> .....	71
• <a href="#">Text</a> .....	71
• <a href="#">Strings</a> .....	71
• <a href="#">Block Data</a> .....	72

#### 6.3.2.1 Numeric Values

Numeric values can be entered in any form, i.e. with sign, decimal point and exponent. Values exceeding the resolution of the instrument are rounded up or down. The mantissa may comprise up to 255 characters, the exponent must lie inside the value range -32000 to 32000. The exponent is introduced by an "E" or "e". Entry of the exponent alone is not permissible. In the case of physical quantities, the unit can be entered. Permissible unit prefixes are G (giga), MA (mega), MOHM and MHZ are also possible), K (kilo), M (milli), U (micro) and N (nano). If the unit is missing, the basic unit is used.

#### 6.3.2.2 Special Numeric Values

The texts MINimum, MAXimum, DEFault, UP and DOWN are interpreted as special numeric values. In case of a query, the numeric value is returned.

- MIN/MAX  
MINimum and MAXimum denote the minimum and maximum value.
- DEF  
DEFault denotes a preset value which has been stored in the EPROM. This value conforms to the default setting, as it is called by the \*RST command
- UP/DOWN  
UP, DOWN increases or reduces the numerical value by one step. The step width can be specified via an allocated step command for each parameter which can be set via UP, DOWN.



- **INF/NINF**  
INFinity, Negative INFinity (NINF) Negative INFinity (NINF) represent the numerical values  $-9.9E37$  or  $9.9E37$ , respectively. INF and NINF are only sent as device response.
- **NAN**  
Not A Number (NAN) represents the value  $9.91E37$ . NAN is only sent as device response. This value is not defined. Possible causes are the division of zero by zero, the subtraction of infinite from infinite and the representation of missing values.

**Example:**

Setting command: `FUSE:DElay MAXimum`

Query: `FUSE:DElay?`, Response: `250`

### 6.3.2.3 Boolean Parameters

Boolean parameters represent two states. The ON state (logically true) is represented by ON or a numerical value unequal to 0. The OFF state (logically untrue) is represented by OFF or the numerical value 0. The numerical values are provided as response for query.

**Example:**

Setting command: `POWer:PROTection OFF`

Query: `POWer:PROTection?`, Response: `0`

### 6.3.2.4 Text

Text parameters observe the syntactic rules for key words, i.e. they can be entered using a short or long form. Like any parameter, they have to be separated from the header by a white space. In the case of a query, the short form of the text is provided.

**Example:**

Setting command: `VOLTage:PROTection:MODE MEASured`

Query: `VOLTage:PROTection:MODE?`, Response: `MEAS`

### 6.3.2.5 Strings

Strings must always be entered in quotation marks (' or ").

**Example:**

`SYSTem:LANGuage "SCPI"` or `SYSTem:LANGuage 'SCPI'`

### 6.3.2.6 Block Data

Block data are a transmission format which is suitable for the transmission of large amounts of data. A command using a block data parameter has the following structure:

**Example:**

```
HEADer:HEADer #45168xxxxxxxx
```

ASCII character # introduces the data block. The next number indicates how many of the following digits describe the length of the data block. In the example, the four following digits indicate the length to be 5168 bytes. The data bytes follow. During the transmission of these data bytes all end or other control signs are ignored until all bytes are transmitted.

### 6.3.3 Structure of a Program Message

A program message may consist of one or several commands. It is terminated by the program message terminator which is the NL (New Line) character for LAN and USB connections.

Several commands in a program message must be separated by a semicolon ";". If the next command belongs to a different command system, the semicolon is followed by a colon ":". A colon ":" at the beginning of a command marks the root node of the command tree.

### 6.3.4 Responses to Queries

A query is defined for each setting command unless explicitly specified otherwise. It is formed by adding a question mark to the associated setting command. According to SCPI, the responses to queries are partly subject to stricter rules than in standard IEEE 488.2.

- The requested parameter is transmitted without header.

**Example**

```
VOLTage:PROTection:MODE?
```

```
Response: PROT
```

- Maximum values, minimum values and all further quantities, which are requested via a special text parameter are returned as numerical values.

**Example**

```
FUSE:DELaY? MAX
```

```
Response: 250
```

- Numerical values are output without a unit. Physical quantities are referred to the basic units or to the units set using the Unit command.

**Example**

```
FUSE:DELaY? MIN
```

```
Response: 0 (for 0 ms)
```

- Truth values <Boolean values> are returned as 0 (for OFF) and 1 (for ON).

**Example**

POWer:PROTection?

Response: 0 (for OFF)

- Text (character data) is returned in a short form.

**Example**

VOLTage:PROTection:MODE?

Response: MEAS (for Measured)

## 6.4 Command Sequence and Command Synchronization

What has been said above makes clear that all commands can potentially be carried out overlapping. In order to prevent an overlapping execution of commands, one of the commands \*OPC, \*OPC? or \*WAI must be used. All three commands cause a certain action only to be carried out after the hardware has been set. By suitable programming, the controller can be forced to wait for the respective action to occur.

For more information, see [Table 6-2](#)

**Table 6-2: Synchronization using \*OPC, \*OPC? and \*WAI**

Command	Action	Programming the controller
*OPC	Sets the Operation Complete bit in the ESR after all previous commands have been executed.	<ul style="list-style-type: none"> <li>• Setting bit 0 in the ESE</li> <li>• Setting bit 5 in the SRE</li> <li>• Waiting for service request (SRQ)</li> </ul>
*OPC?	Stops command processing until 1 is returned. This is only the case after the Operation Complete bit has been set in the ESR. This bit indicates that the previous setting has been completed.	Sending *OPC? directly after the command whose processing should be terminated before other commands can be executed.
*WAI	Stops further command processing until all commands sent before *WAI have been executed.	Sending *WAI directly after the command whose processing should be terminated before other commands are executed.

For a couple of commands, the synchronization to the end of command execution is mandatory in order to obtain the desired result. The affected commands require either more than one measurement in order to accomplish the desired instrument setting (e.g. auto range functions), or they require a longer period of time for execution. If a new command is received during execution of the corresponding function, this may either lead to either to an aborted measurement or to incorrect measurement data.

## 6.5 Remote Control - Commands

The following chapters provide a detailed description of all the remote control commands currently available for the R&S NGE100B and its firmware options.

### 6.5.1 Common Commands

The common commands are taken from the IEEE 488.2 (IEC 625-2) standard. A particular command has the same effect on different devices. The headers of these commands consist of an asterisk "\*" followed by three letters.

- [\\*CLS](#) on page 74
- [\\*ESE](#) on page 74
- [\\*ESR?](#) on page 74
- [\\*IDN?](#) on page 75
- [\\*OPC](#) on page 75
- [\\*OPT?](#) on page 75
- [\\*RST](#) on page 75
- [\\*STB?](#) on page 75
- [\\*WAI](#) on page 75

---

#### \*CLS

Clear status

Sets the status byte (STB), the standard event register (ESR) and the `EVENT` part of the `QUESTionable` and the `OPERation` registers to zero. The command does not alter the mask and transition parts of the registers. It clears the output buffer.

**Usage:**                      Setting only

---

#### \*ESE <Value>

Event status enable

Sets the event status enable register to the specified value. The query returns the contents of the event status enable register in decimal form.

**Parameters:**

<Value>                      Range:      0 to 255

---

#### \*ESR?

Event status read

Returns the contents of the event status register in decimal form and subsequently sets the register to zero.

**Return values:**

<Contents>                      Range:      0 to 255

**Usage:**                      Query only

---

**\*IDN?**

Identification

Returns the instrument identification.

**Return values:**

<ID> "Rohde&Schwarz,<device type>,<part number>/serial number,<firmware version>"

**Example:** Rohde&Schwarz, NGE103B, 5601.1414k03/100421, 1.20

---

**\*OPC**

Operation complete

Sets bit 0 in the event status register when all preceding commands have been executed. This bit can be used to initiate a service request. The query form writes a "1" into the output buffer as soon as all preceding commands have been executed. This is used for command synchronization.

---

**\*OPT?**

Option identification query

Queries the options included in the instrument. For a list of all available options and their description refer to the data sheet.

**Usage:** Query only

---

**\*RST**

Reset

Sets the instrument to a defined default status. The default settings are indicated in the description of commands.

**Usage:** Setting only

---

**\*STB?**

Status byte query

Reads the contents of the status byte in decimal form.

**Usage:** Query only

---

**\*WAI**

Wait to continue

Prevents servicing of the subsequent commands until all preceding commands have been executed and all signals have settled (see also command synchronization and \*OPC).

**Usage:** Event

## 6.5.2 System Commands

The following commands perform the various system functions and configure the communication interface (LAN, WLAN) for the instrument.

---

### SYSTem:BEEPer[:IMMEDIATE]

The instrument returns a single beep immediately.

**Usage:** Event

---

### SYSTem:LOCAL

This command sets the system to front panel control. The front panel control is unlocked.

**Usage:** Event

---

### SYSTem:REMOte

This command sets the system to remote state. The front panel control is locked. By pressing **Remote**, the front panel control will be activated.

**Usage:** Event

---

### SYSTem:RWLOCK

This command sets the system to remote state. The front panel control is locked. You are only able to unlock the front panel control via SCPI command [SYSTem:LOCAL](#) on page 76.

**Usage:** Event

---

### SYSTem:OPTion?

This command returns the list of options installed on the instrument.

**Return values:**

<arg0>

**Usage:** Query only

---

**SYSTem:TEST:BEEPer**

The instrument runs the system test: Beeper Test.

**Usage:** Event

---

**SYSTem:TEST:FANCtrl**

The instrument runs the system test: Fan Control Test.

**Usage:** Event

---

**SYSTem:TEST:KEYBacklight**

The instrument runs the system test: Keypad Backlight Test.

**Usage:** Event

---

**SYSTem:TEST:SCReen**

The instrument runs the system test: Screen Color Test.

**Usage:** Event

---

**SYSTem:COMMunicate:SOCKet:DHCP[:STATe] <arg0>**

This command sets or queries LAN interface mode. ON: automatic IP address from DHCP server; OFF: manually set IP address.

Available only if option R&S NGE-K101 is installed.

**Parameters:**

<arg0>

---

**SYSTem:COMMunicate:SOCKet:IPADdress?**

This command queries IP address of the LAN interface.

Available only if option R&S NGE-K101 is installed.

**Return values:**

<arg0>

**Usage:** Query only

---

**SYSTem:COMMunicate:WLAN:CONNect**

The instrument connects to the predefined wireless access point.

Available only if option R&S NGE-K102 is installed.

**Usage:** Event

---

**SYSTem:COMMunicate:WLAN:DISConnect**

The instrument stops the connection to the predefined wireless access point.

Available only if option R&S NGE-K102 is installed.

**Usage:** Event

---

**SYSTem:COMMunicate:WLAN:IPADdress?**

This command queries the IP address of the device when the wireless interface works as a client.

Available only if option R&S NGE-K102 is installed.

**Return values:**

<arg0>

**Usage:** Query only

---

**SYSTem:COMMunicate:WLAN[:STATe] <arg0>**

This command activates/deactivates or queries the enable state of the wireless interface.

Available only if option R&S NGE-K102 is installed.

**Parameters:**

<arg0>

---

**SYSTem:COMMunicate:WLAN:PASSword <arg0>**

This command defines the password string of the Access Point when the wireless interface works as a client.

Available only if option R&S NGE-K102 is installed.

**Parameters:**

<arg0>

**Usage:** Setting only

---

**SYSTem:COMMunicate:WLAN:SSID <arg0>**

This command defines or queries the SSID string of the access point when the wireless interface works as a client.

Available only if option R&S NGE-K102 is installed.

**Parameters:**

<arg0>



### 6.5.3 Firmware Update

---

**DIAGnostic:SERvice:FWUP** <arg0>

Starts instrument firmware update remotely.

For more information, see [Chapter 5.7.6, "Updating the Firmware"](#), on page 56.

**Parameters:**

<arg0>

**Example:**                   DIAGnostic:SERvice:FWUP "NGE100FWRelease.tar.gz.enc"

**Usage:**                     Setting only

### 6.5.4 HCOPI

---

**HCOPI:DATA?**

This command queries current screen content. BMP format is supported.

**Return values:**

<arg0>

**Usage:**                     Query only

---

**HCOPI:SIZE:X?**

This command returns the horizontal expansion of the screenshots.

**Return values:**

<arg0>

**Usage:**                     Query only

---

**HCOPI:SIZE:Y?**

This command returns the vertical expansion of the screenshots.

**Return values:**

<arg0>

**Usage:**                     Query only

### 6.5.5 Channel Selecting

---

**INSTRument:NSElect** <arg0>

This command defines or queries the numeric selection of a channel. Each channel of the power supply is considered as separate "instrument", which is required by the SCPI standard.

**Parameters:**

<arg0> {1 | 2 | 3}

**Example:**

```
INSTRument:NSElect 1
Selects the output channel as Ch 1.
Note: Channel 3 is only valid for NGE103B.
INSTRument:NSElect? -> 1
Return the numeric channel selection.
```

**INSTRument[:SElect] <arg0>**

This command defines or queries the channel selection. Each channel of the power supply is considered as separate "instrument", which is required by the SCPI standard.

**Parameters:**

<arg0> OUTPut1 | OUTPut2 | OUTPut3 | OUTP1 | OUTP2 | OUTP3 |  
OUT1 | OUT2 | OUT3

**OUTPut1 | OUTP1**

Ch 1

**OUTPut2 | OUTP2**

Ch 2

**OUTPut3 | OUTP3**

Ch 3

**Example:**

```
INSTRument OUTPut1
INSTRument OUTP1
Selects the output channel as Ch 1.
INST? -> 2
Return the output channel as Ch 2.
```

## 6.5.6 Output Setting

**OUTPut[:STATe] <arg0>**

This command defines or queries for output state for the previous selected channel.

**Parameters:**

<arg0> {OFF | ON | 0 | 1}

**ON | 1**

Output state will be turned on.

**OFF | 0**

Output state will be turned off.

\*RST: OFF | 0

**Example:**

```
INST OUT1
OUTP ON
Ch 1 and output state will be activated; i.e. Ch 1 and Output key
on the front panel will be illuminated.
OUTP? -> 1
Return the output state.
```

---

### OUTPut:GENeral <arg0>

This command activates or queries the instrument master output state.

If the master output state is activated, the **Output** key on the front panel will be illuminated.

**Parameters:**

<arg0> {OFF | ON | 0 | 1}

**ON | 1**  
Output state will be activated

**OFF | 0**  
Output state will be deactivated

**Example:**

```
INST OUT1
OUTP:SEL ON
Volt 12
Curr 0.1
Ch 1 is activated.

INST OUT2
OUTP:SEL ON
Volt 12
Curr 0.2
Ch 2 is activated.
OUTP:GEN ON
Ch 1 and Ch 2 and Output state are activated.
OUTP:GEN? -> 1
Return output state of the channel.
```

---

### OUTPut:MODE?

Queries the output operating mode of the previous selected channel

**Return values:**

<arg0> {OFF | CV | CC}

**OFF**  
Output is turned off.

**CV**  
Output mode changed to constant voltage mode.

**CC**  
Output mode changed to constant current mode.

\*RST: OFF

**Example:**            `OUTP:MODE? -> CV`  
                          Output mode has changed to constant voltage mode.

**Usage:**             Query only

### **OUTPut:SELEct <arg0>**

This command activates or queries the instrument channel state of the previous selected channel.

If the selected channel is activated, the respective channel key (i.e. **Ch 1**, **Ch 2**, **Ch 3**) on the front panel will be illuminated.

**Parameters:**

<arg0>                {OFF | ON | 0 | 1}  
                          **ON | 1**  
                          Selected channel will be activated.  
                          **OFF | 0**  
                          Selected channel will be deactivated.  
                          \*RST:            OFF | 0

**Example:**            `INST OUT1`  
                          `OUTP:SEL ON`  
                          Ch 1 is activated.

`OUTP:SEL? -> 1`

Return the state of the selected channel.

### **OTP:TRIPped?**

Queries the overtemperature protection (OTP) tripped state of the previous selected channel.

It is tripped if an OTP event occurs. Available from V1.50

**Return values:**

<arg0>                {OFF | ON | 0 | 1}  
                          **ON | 1**  
                          OTP event occurs.  
                          **OFF | 0**  
                          OTP event not occurs.  
                          \*RST:            OFF | 0

**Example:**            `OUTP:TRIP? -> 1`  
                          OTP event occurs.

**Usage:**             Query only

## 6.5.7 Fuse Setting

### FUSE:DELay <Delay>

This command defines and queries the fuse delay for the previous selected channel.

#### Parameters:

<Delay> {<Delay> | MIN | MAX}

**<delay>**  
0 ms to 10 s (adjustable in 10 ms steps e.g. FUSE:DEL 10 = 10 ms)

**MIN**  
Set fuse delay to minimum.

**MAX**  
Set fuse delay to maximum.

Default unit: ms

#### Example:

```
INST OUT1
FUSE:DEL 50
Set fuse delay of channel 1 to 50 ms.
FUSE:DEL? -> 50
Return the fuse delay time of the selected channel.
```

### FUSE:LINK <arg0>

This command defines or queries the channel fuses (fuse linking) for the previous selected channel.

#### Parameters:

<arg0> {1 | 2 | 3}

**1**  
channel Ch 1

**2**  
channel Ch 2

**3**  
channel Ch 3

#### Example:

```
INST OUT1
FUSE:LINK 2
Fuse Ch 1 is linked with Ch 2
FUSE:LINK? 2 -> 1
If the fuse of Ch 1 is linked with Ch 2, a "1" is returned.
FUSE:LINK? 3 -> 0
If the fuse of Ch 1 is not linked with Ch 3, a "0" is returned.
```

### FUSE:TRIPped?

This command queries the fuse tripped of the previous selected channel.

**Return values:**

<arg0>           **ON**  
Fuse is tripped.

**OFF**  
Fuse is not tripped.

**Example:**

```
INST OUT1
FUUSE:TRIP? -> 0
Fuse of Ch 1 has not tripped.
```

**Usage:**

Query only

**FUUSE:UNLink** <arg0>

This command unlinks the channel fuses (fuse linking) for the previous selected channel.

**Parameters:**

<arg0>           {1 | 2 | 3}

**1**  
channel Ch 1

**2**  
channel Ch 2

**3**  
channel Ch 3

**Example:**

```
INST OUT1
FUUSE:LINK 2
FUUSE:UNL 2
Fuse Ch 1 is unlinked with Ch 2
```

**Usage:**

Setting only

**FUUSE[:STATe]** <arg0>

This command defines or queries the fuse for the previous selected channel.

**Parameters:**

<arg0>           {0 | 1}

**1**  
Fuse will be activated.

**0**  
Fuse will be deactivated.

\*RST:           OFF | 0

**Example:**

```
INST OUT1
FUUSE ON
Fuse of Ch 1 is activated
FUUSE? -> 1
Return fuse state of the selected channel.
```

## 6.5.8 OVP Setting

---

**[SOURce:]VOLTage:PROTection:MODE <arg0>**

This command defines or queries the OVP mode for the previous selected channel.

**Parameters:**

<arg0> MEASured | PROTection

**MEASured**

The OVP switches off if the measured value exceeds the threshold.

**PROTection**

If the adjusted threshold is exceeded the output of the instrument will be not switched on; additionally the measured value is monitored (please also refer to function MEASured).

**Example:**

```
INST OUT1
VOLT:PROT:MODE PROT
Sets OVP protected mode for Ch 1.
VOLT:PROT:MODE? -> PROT
Return the selected channel OVP mode.
```

---

**[SOURce:]VOLTage:PROTection:TRIPped?**

This command queries the OVP tripped status of the previous selected channel.

**Return values:**

<arg0> ON | OFF

**ON**  
OVP is tripped

**OFF**  
OVP is not tripped

**Example:**

```
INST OUT1
VOLT:PROT:TRIP? -> OFF
OVP of Ch 1 has not tripped.
```

**Usage:** Query only

---

**[SOURce:]VOLTage:PROTection[:STATE] <arg0>**

This command defines or queries the OVP state for the previous selected channel.

**Parameters:**

<arg0> 1 | 0

**1**  
OVP is activated.

**0**  
OVP is deactivated.

**Example:**

```
INST OUT1
VOLT:PROT ON
OVP of Ch 1 is activated.
VOLT:PROT? -> 1
Return the OVP state of the selected channel.
```

---

### **[SOURce:]VOLTage:PROTection:LEVel <Voltage>**

This command defines or queries the OVP value of the previous selected channel.

#### **Parameters:**

<Voltage> {<Voltage> | MIN | MAX}

**<Voltage>**  
Set the OVP value in the range of 0 mV up to 32.2 V (adjustable in 100 mV steps)

**MIN**  
Set the OVP value to minimum.

**MAX**  
Set the OVP value to maximum.

Default unit: V

**Example:**

```
INST OUT1
VOLT:PROT:LEV 5
Set the OVP value of Ch 1 to 5 V.
VOLT:PROT:LEV?
Return the selected channel OVP value.
```

---

### **[SOURce:]VOLTage:PROTection:CLEar**

This command resets the OVP state of the selected channel. If the OVP has tripped the OVP message on the display will be cleared for the selected channel.

**Usage:** Event

## **6.5.9 OPP Setting**

---

### **[SOURce:]POWER:PROTection:LEVel <Power>**

This command defines or queries the OPP value of the previous selected channel.



**Parameters:**

**<Power>** {<Voltage> | MIN | MAX}  
**<Voltage>**  
 Set the OPP value in the range of 0 W up to 32 W (adjustable in 100 mW steps)  
**MIN**  
 Set the OPP value to minimum.  
**MAX**  
 Set the OPP value to maximum  
 Default unit: W

**Example:**

```
INST OUT1
POW:PROT:LEV 5
Set the OPP value of channel 1 to 5 W.
POW:PROT:LEV? -> 5
Return the selected channel OPP value.
```

**[SOURce:]POWER:PROTection:TRIPped?**

This command queries the OPP tripped status of the previous selected channel

**Return values:**

**<arg0>** 1 | 0  
**1**  
 OPP is tripped.  
**0**  
 OPP is not tripped.

**Example:**

```
INST OUT1
POW:PROT:TRIP? -> 0
OPP state of Ch 1 has not tripped.
```

**Usage:**

Query only

**[SOURce:]POWER:PROTection[:STATe] <arg0>**

This command defines or queries the OPP state for the previous selected channel.

**Parameters:**

**<arg0>** ON | OFF | 1 | 0  
**ON | 1**  
 OPP is activated.  
**OFF | 0**  
 OPP is deactivated.

**Example:**

```
INST OUT1
POW:PROT ON
OPP of Ch 1 is activated.
POW:PROT?
Return the OPP state of the selected channel.
```

**[SOURce:]POWER:PROTection:CLEAr**

This command resets the OPP state of the selected channel. If the OPP has tripped the red blinking OPP message on the display will be cleared for the selected channel.

**Usage:** Event

**6.5.10 Measurement Commands****MEASure[:SCALar]:CURRent[:DC]?**

This command queries the measured current value of the previous selected channel.

**Return values:**

<Current>                    **<numeric\_value>**  
Return the measured current.  
Default unit: A

**Example:**                    MEAS:CURR? -> 1.000

**Usage:** Query only

**MEASure[:SCALar]:POWer?**

This command queries the measured power value of the previous selected channel.

**Return values:**

<Power>                        **<Numeric\_value>**  
Return the measured power value.  
Default unit: W

**Example:**                    MEAS:POW? -> 3.00E+00  
Return the measured power value of the selected channel.

**Usage:** Query only

**MEASure[:SCALar][:VOLTage][:DC]?**

This command queries the measured voltage value of the previous selected channel.

**Return values:**

<Voltage>                       **<numeric\_value>**  
Return the measured voltage.  
Default unit: V

**Example:**                    MEAS? -> 1.000E+00

**Usage:** Query only

### 6.5.11 Voltage and Current Configuration Commands

#### APPLY <arg0>

This command defines or queries the voltage and current value of the selected channel.

#### Parameters:

<arg0>                    {<Voltage> | DEF | MIN | MAX} [, {<Current> | DEF | MIN | MAX}]

#### <Voltage>

Set voltage in the range of 0 V to 32.20 V.

#### DEF

Set voltage to default.

#### MIN

Set voltage to minimum .

#### MAX

Set voltage to maximum.

#### <Current>

Set current in the range of 3 mA to 3.025 A.

#### DEF

Set current to default.

#### MIN

Set current to minimum.

#### MAX

Set current to maximum.

#### Example:

```
INST OUT1
APPLY "6,2"
Set channel 1 to output 6 V and 2 A.
APPLY? -> 6, 2
Return voltage and current value of the selected channel.
```

#### [SOURce:]CURRENT[:LEVel][:IMMediate][:AMPLitude] <Current>

This command defines or queries the current value of the selected channel.

#### Parameters:

<Current>                    **<Current>**  
Set the selected channel to a current range of 3 mA to 3.025 A  
Default unit: A

#### Example:

```
CURR 2
Set the selected channel current to 2 A.
CURR? -> 2
Return current value of the selected channel .
```

#### [SOURce:]VOLTage[:LEVel][:IMMediate][:AMPLitude] <Voltage>

This command defines or queries the voltage value of the selected channel.

**Parameters:**

<Voltage> {<Voltage> | MINimum | MAXimum | DEFault}  
**<Voltage>**  
 0.0 V to 32.2 V (adjustable in 10 mV steps)  
**MINimum**  
 0.000E+00  
**MAXimum**  
 32.200E+01  
 Default unit: V

**Example:**

VOLT 10  
 Set the voltage value to 10 V.  
 VOLT? -> 10  
 Return the voltage value of the selected channel.

## 6.5.12 EasyRamp Commands

---

**[SOURce:]VOLTage:EASyramp[:STATe] <arg0>**

This command activates/deactivates or queries the EasyRamp state for the previous selected channel.

See also SOURce:VOLTage:RAMP:STATe.

**Parameters:**

<arg0>

---

**[SOURce:]VOLTage:EASyramp:TIME <Time>**

This command sets/queries the EasyRamp time of the previous selected channel in milliseconds. 10 ms to 10 s in steps of 10 ms.

See also SOURce:VOLTage:RAMP:DURation.

**Parameters:**

<Time> Range: 10 to 10000  
 \*RST: 10  
 Default unit: ms

---

**[SOURce:]VOLTage:RAMP:DURation <Time>**

This command sets/queries the EasyRamp duration of the previous selected channel in mili seconds. 10ms to 10 seconds in steps of 10 ms.

**Parameters:**

<Time> Range: 10 to 10000  
 \*RST: 10  
 Default unit: ms

**[SOURce:]VOLTage:RAMP[:STATe] <arg0>**

This command defines/queries the EasyRamp state for the previous selected channel.

**Parameters:**

<arg0> {OFF | ON}

**ON**  
EasyRamp function is activated.

**OFF**  
EasyRamp function is disabled.

**6.5.13 Arbitrary Commands****ARbitrary:CLEAr**

This command clears the previous defined arbitrary waveform data for channel 1.

**Usage:** Event

**ARbitrary:DATA <arg0>**

Defines or queries the arbitrary points for channel 1. The dwell time between two points is from 10ms to 600s.

**Parameters:**

<arg0> <Voltage1, Current1, Time1, Voltage2, Current2, Time2,..., Voltage128, Current128, Time128>

**Voltage1 ... Voltage128**

Defines the arbitrary points of the voltage.

**Current1 ... Current128**

Defines the arbitrary points of the current.

**Time1 ... Time128**

Defines the arbitrary points of the time (The unit for time is ms).

**Example:** ARB:DATA "10.5,3,10,20,2,1000,15,2.1,10000"

**ARbitrary:RCL <arg0>**

This command recalls EasyArb settings and previous defined arbitrary points from the respective memory locations M1-M5.

**Parameters:**

<arg0> Range: 0..4

**Usage:** Setting only

**ARbitrary:REPetitions** <Repetitions>

This command defines or queries the repetition of the defined arbitrary waveform for channel 1.

Note: If the repetition is set to "0", the arbitrary waveform repeats continuously.

**Parameters:**

<Repetitions>            0..255

**Example:**

```
ARB:REP 10
```

Set the repetition rate of the defined arbitrary waveform as 10.

```
ARB:REP? -> 10
```

Return the defined repetition rate of the selected channel.

**ARbitrary:POINTs?**

This command returns the number of arbitrary points of EasyArb waveform.

**Return values:**

<arg0>

**Usage:**                    Query only

**ARbitrary[:STATe]** <arg0>

This command activates/deactivates or queries the EasyArb state. ON: Ch 1 is ready to run arb waveform.

**Parameters:**

<arg0>

**ARbitrary:SAV** <arg0>

This command saves EasyArb settings and previous defined arbitrary points into the respective memory locations M1-M5.

**Parameters:**

<arg0>                    Range:     0..4

**Example:**

```
INST 1
ARB:DATA 10,1,0,5,0
ARB:REP 10
ARB:SAV 1
```

**Usage:**                    Setting only

**ARbitrary:START**

This command starts the previous transferred EasyArb waveform in channel 1 if Easy-Arb is enabled.

**Usage:**                    Event

---

**ARbitrary:STOP**

This command stops the EasyArb waveform in channel 1 if EasyArb is running.

**Usage:** Event

### 6.5.14 DIO Commands

---

**TRIGGER:DIRrection:DIO<IO> <arg0>**

This command sets or queries the specified Digital I/O line to function as Trigger Input or Trigger Output.

**Suffix:**

<IO> 1..4

**Parameters:**

<arg0> OUTPut | INPut

**Example:** TRIG:DIR:DIO2 OUT

---

**TRIGGER[:ENABLE]:DIO<IO> <arg0>**

This command sets or queries the state of the specified Digital I/O line.

The state is disabled when any setting has been changed

**Suffix:**

<IO> 1..4

**Parameters:**

<arg0> {OFF | ON}

**ON**

Enable the state for Digital I/O line.

**OFF**

Disable the state for Digital I/O line.

---

**TRIGGER:IN:ARbitrary:DIO<IO> <arg0>**

This command sets or queries the operation mode when starting EasyArb by Trig IN.

**Suffix:**

<IO> 1..4

**Parameters:**

&lt;arg0&gt;

PULSe | LEVeL

**PULSe**

Starts EasyArb when trigger signal activated.

**LEVeL**

Starts EasyArb when trigger signal activated and stops when trigger signal de-activated.

\*RST: PULSe

**Example:**

TRIG:IN:ARB:DIO1 PULS

**TRIGger:IN:RESPonse:DIO<IO>** <arg0>

This command sets or queries the output response of the trigger input of the specified Digital I/O line.

**Suffix:**

&lt;IO&gt;

1..4

**Parameters:**

&lt;arg0&gt;

ON | OFF | TOGGle | INHibit | ARBitary

**ON**

Output is switched on.

**OFF**

Output is switched off.

**TOGGle**

Output state is toggled.

**INHibit**

Output state remains off as long as the TRIG IN signal is activated.

**ARBitary**

Starts the EasyArb function. If level signal is selected, the EasyArb function is stopped when TRIG IN signal is deactivated.

\*RST: OFF

**TRIGger:IN:SOURce:DIO<IO>** <arg0>

This command sets or queries the source under control of the trigger input of the specified Digital I/O line.

**Suffix:**

&lt;IO&gt;

1..4



**Parameters:**

<arg0> CH1 | CH2 | CH3

**CH1**  
Trigger input source from Ch 1.

**CH2**  
Trigger input source from Ch 2.

**CH3**  
Trigger input source from Ch 3.

\*RST: CH1

**TRIGger:LOGic:DIO<IO> <arg0>**

This command sets or queries the trigger logic (Active High/Active Low) of the specified Digital I/O line..

**Suffix:**

<IO> 1..4

**Parameters:**

<arg0> LOW | HIGH

\*RST: HIGH

**TRIGger:OUT:CONDition:DIO<IO> <arg0>**

This command sets the trigger condition of the trigger output of the specified Digital I/O line.

The line triggers when the output of the specified control source is turned off or on

**Suffix:**

<IO> 1..4

**Parameters:**

<arg0> ON | OFF | FUSetrip | CCMODE | VOLTlevel | CURRlevel | CRITevent | ARBITrary

**ON**  
Trigger output is turned on.

**OFF**  
Trigger output is turned off.

**FUSetrip**  
Trigger output is linked to fuse tripped event.

**VOLTlevel**  
Trigger output is linked to a set voltage level event.

**CURRlevel**  
Trigger output is linked to a set current level event.

**CRITevent**  
Trigger output is linked to a critical triggered event.

**ARBITrary**  
Trigger output is linked to a EasyArb event.

\*RST: ON

**TRIGger:OUT:CRITevent:DIO<IO> <arg0>**

This command sets or queries the critical event of the trigger output of the specified Digital I/O line.

**Suffix:**

<IO> 1..4

**Parameters:**

<arg0> OVP | OPP | OTP

**OVP**  
Trigger output is linked to the OVP event

**OPP**  
Trigger output is linked to the OPP event

**OTP**  
Trigger output is linked to the OTP event

\*RST: OVP

**TRIGger:OUT:CURRlevel:DIO<IO> <Current>**

This command sets or queries the threshold current level of the the trigger output of the specified Digital I/O line.

Triggers when output current level exceeds or equals to the set level.

**Suffix:**

<IO> 1..4

**Parameters:**

<Current>                    \*RST:        3.000  
                                   Default unit: A

**TRIGger:OUT:SOURce:DIO<IO>** <arg0>

This command sets or queries the control source of the trigger output of the specified Digital I/O line.

**Suffix:**

<IO>                            1..4

**Parameters:**

<arg0>                        CH1 | CH2 | CH3  
                                   \*RST:        CH1

**TRIGger:OUT:VOLTlevel:DIO<IO>** <Voltage>

This command sets or queries the threshold voltage level of the the trigger output of the specified Digital I/O line.

Triggers when output voltage level exceeds or equals to the set level.

**Suffix:**

<IO>                            1..4

**Parameters:**

<Voltage>                    \*RST:        0.0  
                                   Default unit: V

**TRIGger:RCL** <arg0>

This command recalls DIO settings from the respective memory locations M1-M5.

**Parameters:**

<arg0>                        Range:        0..4

**Example:**                    TRIG:RCL 1

**Usage:**                      Setting only

**TRIGger:SAV** <arg0>

This command saves DIO settings into the respective memory locations M1-M5

**Parameters:**

<arg0>                        Range:        0..4

**Example:**                    TRIG:SAV 1

**Usage:**                      Setting only

## 7 Applications

### 7.1 Parallel and Serial Mode

#### **WARNING**

It is assumed that only qualified and trained personnel service the power supplies and the connected loads.

#### **NOTICE**

Use only the R&S NGE100B power supply series when operating the channels in a serial or parallel mode to increase the output voltage and current.

#### **DANGER**

##### **Serial connection**

A serial connection may cause dangerous voltages.

To increase output voltage and currents, it is possible to operate the channels in serial or parallel mode. In general, the output voltages of R&S NGE100B to be combined are independent.

#### 7.1.1 Serial Mode

This type of interconnection adds the individual output voltages. The same current flows through all outputs. The current limits for the outputs wired in series should be set to the identical value. If one of the outputs exceeded the current limit, the total voltage will naturally collapse. See [Chapter 5.3, "Output Modes"](#), on page 34.

It is advisable to set the voltages of all connected channels voltages to a similar value to distribute the loads evenly (not absolutely necessary). When all three channels are connected in a serial mode and if a (low resistance) load is connected; there is a chance of damaging a channel when that channel is switch off. This is due to the protection diode working as a bypass to connect the other channel in a serial mode. Once the protection diode is shorted, the channel will be defective.

Therefore, it is necessary to always have all channels or no channel at all switched on.



If the instrument switches to constant current output mode (CC) during a serial connection, the voltage display becomes inaccurate.

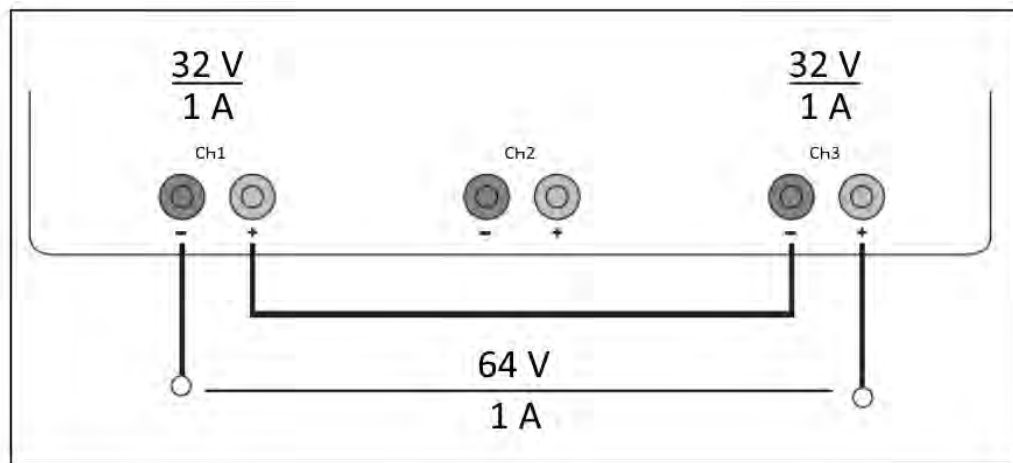

Figure 7-1: Example of serial connection

### 7.1.2 Parallel Mode

If it is necessary to increase the total current, the power supply outputs must be wired in parallel. The maximum total current is the sum of the individual currents of all sources connected in parallel. The output voltages for the individual outputs should be set to the same voltage value as precisely as possible. For slight voltage differences, it is common in this operating mode to first charge a voltage output up to the current limit; the other voltage output provides the remaining current. See "[Principles of operation in parallel mode](#)" on page 100.

For power supplies that are connected in parallel, it is possible that compensating currents flow within the power supplies. The use of power supplies by other manufacturers, which are potentially not overload proof, can cause destruction of these units as currents may be distributed unevenly.

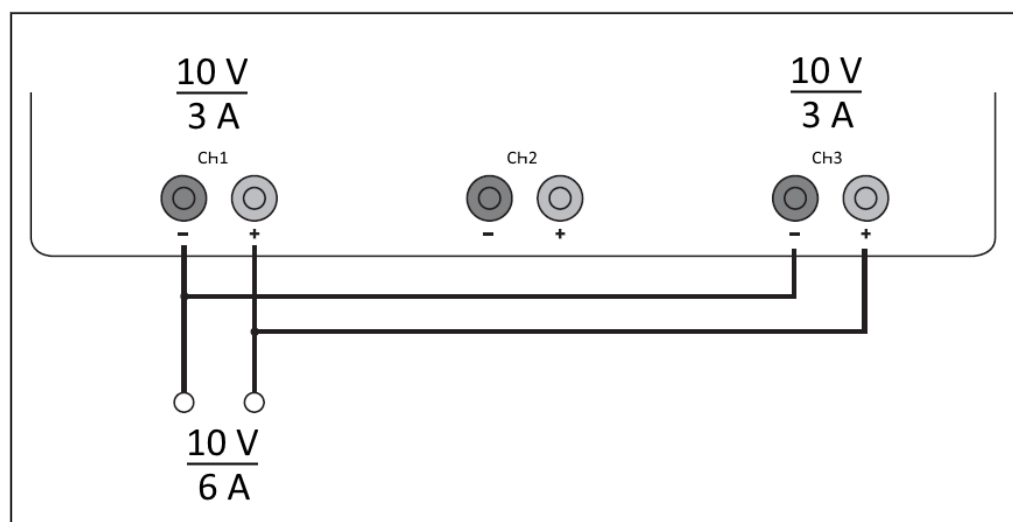

Figure 7-2: Example of parallel connection

**Principles of operation in parallel mode**

Generally, a higher current will first be supplied from the channel with the higher output voltage. Once this channel reaches its power limit, the remaining current will be made available by the channel that is connected in parallel. In this scenario, it is unpredictable which channel will supply the higher current because it is also possible for channels with identical voltage values to display a low voltage difference.

By increasing the voltage slightly, the load distribution can be manipulated. If the voltage for a channel is to be increased by 50mV, for instance (by a set of identical cables), the current will initially be provided by this channel.

If you wish to distribute the load to multiple channels, it is recommended to set the current limit of the channel that is to supply the main current to a fraction of the current. This approach handles the semiconductor with care and improves the heat dissipation, as the power loss is distributed more evenly.

# Index

<b>A</b>	
Activating Fuse .....	37
Activating the Channels Output .....	38
Application cards .....	8
Application notes .....	8
<b>B</b>	
Brochure .....	7
<b>C</b>	
Calibration Certificate .....	7
Clear status	
Remote .....	74
Command sequence	
Remote .....	75
Command Sequence and Command Synchronization .....	73
Connecting to a Network .....	48
LAN Connection .....	48
USB Connection .....	48
Wired Connection .....	48
Wireless Connection .....	48
Controls .....	19
Conventions .....	8
<b>D</b>	
Data Sheet .....	7
Default values	
Remote .....	75
Digital IO .....	45
<b>E</b>	
EasyArb .....	43
EasyRamp .....	44
Event status enable register (ESE)	
Remote .....	74
Event status register (ESR)	
Remote .....	74
<b>F</b>	
Front Panel	
Display .....	19
Function keys .....	19
Output channels .....	19
Power key .....	19
Rotary knob and arrow keys .....	19
USB connector .....	19
Function Keys .....	28
Fuse .....	42
Fuse Delay .....	42
Fuse Linking .....	42
FuseLink .....	42
<b>G</b>	
General Instrument Settings .....	52, 53
Buzzer .....	53
Display .....	53
Display Brightness .....	53
Key Fallback Time .....	53
Keypad .....	53
Sound .....	53
Getting Started .....	7
<b>H</b>	
Help .....	57
<b>I</b>	
Identification	
Remote .....	75
Important notes	
Ambient conditions .....	10
Limits .....	12
Mains voltage .....	11
Measurement categories .....	11
Symbols .....	10
Information .....	52
<b>M</b>	
Maintenance .....	24
Menu .....	32
Mode	
Output Modes .....	34
<b>N</b>	
Navigation Controls	
Arrow Keys .....	30
Rotary Knob .....	30
<b>O</b>	
Open Source Acknowledgment .....	8
Operation complete	
Remote .....	75
Options .....	54
Identification (remote) .....	75
Install Option .....	54
Installation Status .....	54
Output Modes	
Constant Current (CC) .....	34
Constant Voltage (CV) .....	34
<b>P</b>	
Package contents .....	17
Power Derating .....	34
Protection .....	40
Overpower Protection (OPP) .....	40
Overvoltage Protection (OVP) .....	40
<b>R</b>	
Rear Panel	
AC inlet with fuse holder .....	20
Digital I/O connector .....	20
Ethernet connector .....	20
USB connector .....	20
Voltage selector .....	20
Release notes .....	8

Remote Control .....	59
Reset .....	55
Reset values	
Remote .....	75

**S**

Safety instructions .....	7
SCPI Command Structure and Syntax .....	65
Screen Layout .....	25
Selecting the Channels .....	35
Service manual .....	7
Setting Up the Instrument	
Bench Operation .....	17
Rack Mounting .....	17
Status byte	
Remote .....	74, 75
Store and Recall .....	38
Switching On the Instrument .....	22
System Test .....	55

**T**

Tracking Function .....	36
Trying Out the Instrument	
Activating the Channels Output .....	23
Selecting the Channels .....	23
Setting the Output Voltage and Current Limit .....	23
Storing/Recalling of Instrument Settings .....	23

**U**

Unpacking and checking the instrument .....	17
Update .....	56
User Manual .....	7

**V**

Virtual Keyboard .....	29
------------------------	----

**W**

Wait	
Remote .....	75
White papers .....	8



# ALLICE

Messtechnik GmbH

make ALLICE your partner

ALLICE MESSTECHNIK GMBH

KELSTERBACHER STRASSE 15-19 60528 FRANKFURT AM MAIN

TEL.: +49(0)69-67724-583 FAX: +49(0)69-67724-582

INFO@ALLICE.DE

[www.allice.de](http://www.allice.de)

© 2018 ALLICE MESSTECHNIK GMBH - ALLE RECHTE VORBEHALTEN.

© 2018 ALLICE MESSTECHNIK GMBH - ALL RIGHTS RESERVED

VERWENDETE WARENZEICHEN UND SCHUTZRECHTE SIND EIGENTUM DER JEWEILIGEN HERSTELLER.  
LOGOS AND COMPANY NAMES LISTED ARE TRADEMARKS OR TRADE NAMES OF THEIR RESPECTIVE OWNERS.