



SP209 series datasheet and user manual

SP209 and SP209i 9 channels, 200 MSPS logic analyzer with industrial inputs option

www.ikalogic.com | support@ikalogic.com

December 28, 2020

Contents

SP209 Series overview	4
Typical applications	4
Product highlights	5
Warning	6
Main characteristics	7
Operating conditions	7
Timing and measurements	7
Logic inputs specifications	7
Power requirements	7
SP209(i) Interfaces	8
Principle of operation	9
Embedded memory vs streaming	9
Versatile trigger system	9
External trigger OUT specifications	10
External trigger IN specifications	11
Industrial port (SP209i only)	11
RS485 receiver specifications	12
RS232 receiver specifications	12
CAN receiver specifications	12
LIN receiver specifications	13
What's in the box	13
Unpacking and first usage	14
Status LEDs behavior	14
Software Quick Start guide	14
Capturing your first signal	15
Mechanical data	15
Model SP209i	16
Model SP209	17
Probes	18
Software technical requirements	19

Ordering information and customer support	19
Accessories and maintenance	19
Certifications and regulations	19
Safety information	21
Symbols definitions	21
Important safety notes	21
Limited warranty & limitation of liability	22
Document Revisions	23

SP209 Series overview

SP209 series logic analyzers and protocol decoders offer in depth analysis of logic signals and protocols with 200MHz (5ns) timing resolution. 9-channel operation allows 8-bit parallel data to be captured along with a clock or strobe signal.

SP209 Series is composed of two devices, SP209 and SP209i. Both offer 9 logic inputs, but SP209i integrates industrial receivers for CAN, LIN, RS232 and RS485 buses.¹



Figure 1: SP209 Logic Analyzer



Figure 2: sp209i logic analyzer (industrial version)

Typical applications

SP series logic analyzers are perfectly adapted for demanding applications, where it is needed to capture logic signals with maximum time resolution on all 9 channels.

- Embedded systems debugging
- Research and education
- Serial protocols analysis, like I2C, SPI, UART or 1-Wire (non exhaustive list)
- Industrial bus analysis: RS232, RS485, CAN, LIN

¹Industrial receivers in the SP209i are multiplexed with one or more of the existing 9 logic channels

- ADC diagnostic

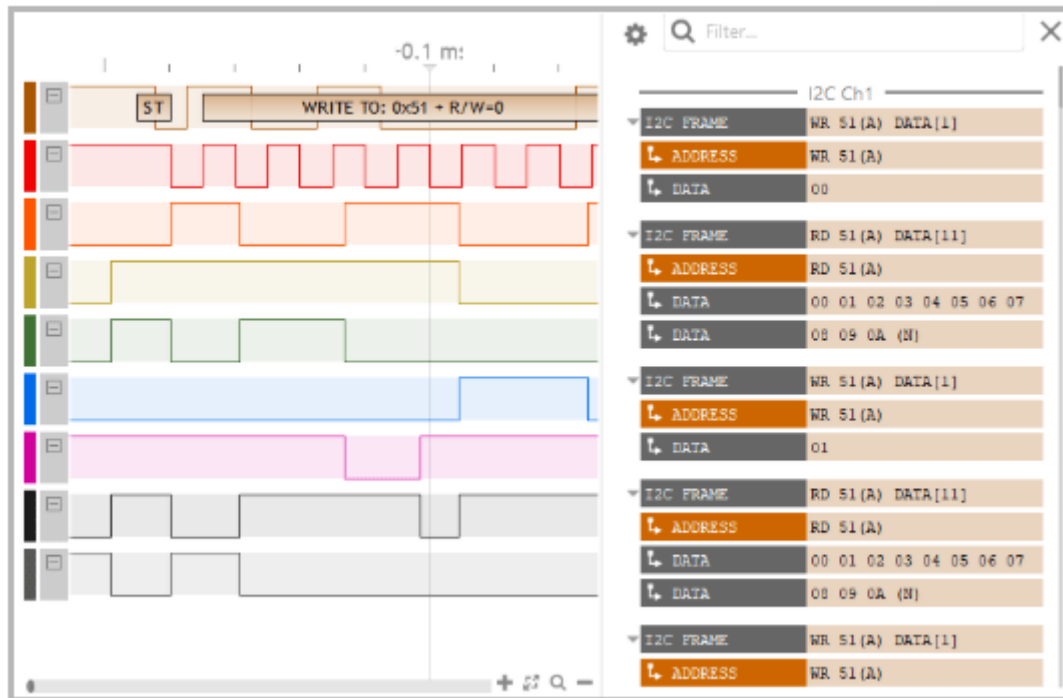

Figure 3: Example of logic signals captured and analyzed by SP209 logic analyzer

Product highlights

- Schmitt trigger input stages with adjustable thresholds
- 200 MHz sampling rate, with all 9 channels used.
- External clock option (state mode), up to 50MHz
- Precise trigger-In and trigger-Out signals on SMA ports

Warning

Read **safety information** section carefully before using this instrument.

Main characteristics

Operating conditions

Temperature	10°C to 40°C
Relative humidity	< 80% non condensing
Altitude	< 2000m

Timing and measurements²

Sampling rate (MAX.)	200 MSPS
External clock Max rate (State mode)	50 MHz
Logic Inputs digital bandwidth	50 MHz
Embedded memory	2 Gb
Trigger output	Yes, via SMA connector
External trigger input	Yes, via SMA connector

Logic inputs specifications

Number of channels	9
Input impedance	200 K Ω 8 pF
Threshold circuits	3
Adjustable logic level (for each threshold)	1.8, 2.5, 3.3, 5V
Absolute max voltage on digital inputs (Continuous or Transient)	\pm 25 V

Power requirements

Input power connector	Micro USB female
Input current	500 mA

²DDR-3 sampling memory is used to buffer samples before streaming to host computer.

Input voltage

 $5\text{ V} \pm 0.25\text{ V}$

SP209(i) Interfaces

SP209(i) logic analyzer ports and interfaces are shown in the diagram below:

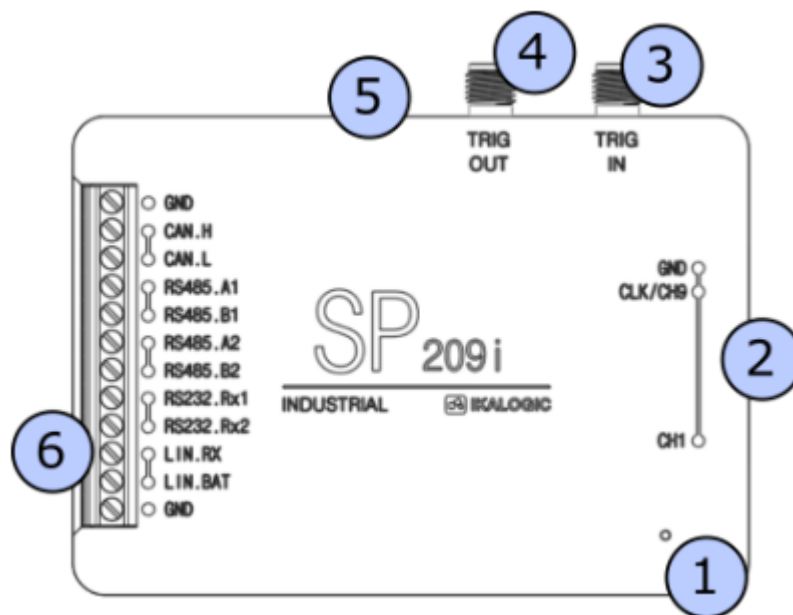

Figure 4: SP209i ports and interfaces

1. Status LED
2. 9-CH logic probes input
3. Trigger OUT SMA connector
4. Trigger IN SMA connector
5. USB (micro-B) port.
6. Industrial port³

³Only on SP209i (industrial) version.

Principle of operation

SP209 Series logic analyzers connects to a computer via a USB cable. A free software - called ScanaStudio - is used to configure the device and display captured signals. The software can also be used to further analyze the captured samples by decoding protocols like I2C, SPI or UART.

Embedded memory vs streaming

USB based logic analyzers (ones that don't have a display and rely on a computer for that matter) usually operate according to one of two schemes:

- Using an **embedded memory** to store captured samples. Samples are later downloaded at a slower speed via the USB interface. This has the advantage of not being limited by USB transfer rate, but has the disadvantage of limited embedded memory.
- **Streaming** captured samples over the USB connection, at the maximum possible speed. While this offers the advantage of a virtually unlimited memory (only limited by host computer's memory), it has the disadvantage of limiting the sampling rate to USB's throughput.

SP209 combines the advantages of both streaming and embedded memory techniques. An embedded 2Gb DDR-3 memory stores captured samples at 200 MHz sampling rate on all channels, while a USB interface compresses and transfers the data simultaneously, effectively emptying the embedded memory and making more room for new samples. This results is a logic analyzer that can capture dozens of minutes of logic signals activity on 9 channels at 200 MSPS.

Versatile trigger system

SP209 series offer a state of the art trigger system. It's composed of two FlexiTrig® trigger engines, each FlexiTrig engine can be used in one of those modes:

- Edge trigger
- Pulse trigger (with minimum and maximum pulse width)
- Timed logic sequence
- Protocol based trigger (e.g. I2C bus address or serial UART character)
- External trigger source

Furthermore, the two trigger engines (called A and B hereafter) can be cascaded in one of the following modes:

- A then B (Wait until A triggers then arm B trigger engine)
- B then A
- A and B (Trigger engines A and B must trigger, but in any order)

- A or B (whoever triggers first)

Finally, an external trigger output is always active, in all modes and generates a trigger pulse whenever a trigger condition is met and a capture starts. Signal specifications for External trigger input and output are detailed in the following section.

External trigger OUT specifications

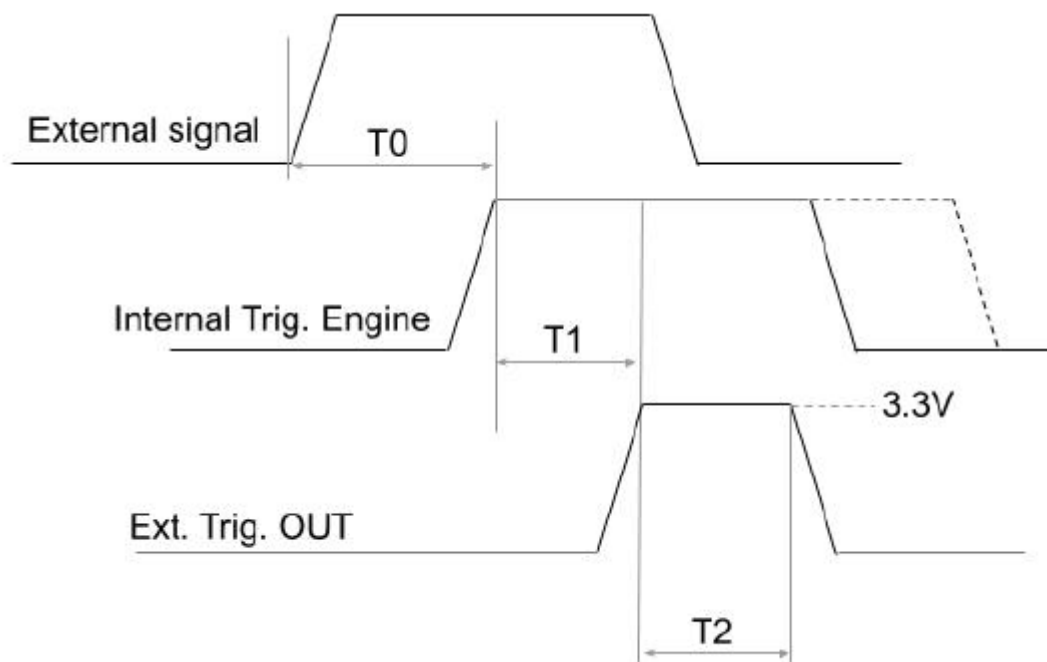

Figure 5: External trigger OUT timings

There is an internal data path delay of 20ns before external signals reach internal trigger engine (T0). When trigger event occurs, 10ms (T2) pulse is generated on the Trig Out port. This port has a 50 Ω series impedance allowing easy interfacing to 50 Ω input devices. This can be used to synchronise the capture with other equipment like an oscilloscope. Polarity of the trigger can be set in software. There is also a 10 ns delay (T1) between internal trigger detection and Trig Out assertion. Therefore, the total time for an external event to generate a Trigger OUT pulse is $T0+T1 = 30$ ns.

External trigger IN specifications

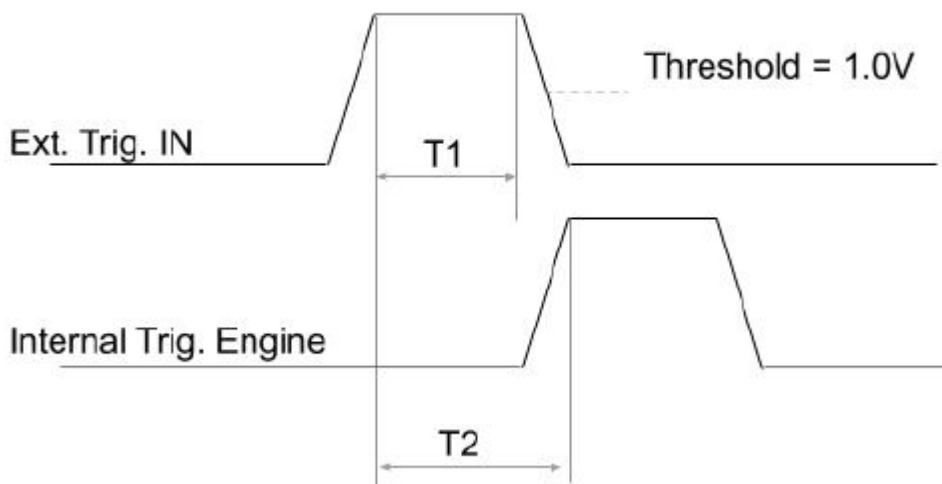

Figure 6: External trigger IN timings

The Trig In port allows to start acquisition on an external event generated by another instrument. The minimum pulse width (T1) is 5ns. Polarity can be set in software. The input impedance is also software selectable (100k Ω or 50 Ω). The threshold level is 1.0V. T2, the time between external trigger in active edge and internal trigger engine assertion is 20ns.

Industrial port (SP209i only)

SP209i offer the possibility to connect directly to industrial buses, as opposed to logic channels which can only be connected to single ended logic level such as LVCMOS or LVTTTL. Each one of the industrial inputs integrates a dedicated receiver circuit, perfectly adapted to each standard. For more reliability in an industrial context, each bus receiver is exposed via screw terminals. Adequate wires (6-30 AWG) should be used to connect SP209i to the bus being probed⁴. Industrial receivers offer the advantage of visualizing exactly what a standard off-the-shelf transceiver would receive if connected to that bus. The list of the industrial inputs is detailed below:

- CAN bus receiver
- RS485 bus receiver (can be combined to form a full duplex RS422 bus receiver)
- RS232 receivers

⁴Wires to connect SP209i to industrial buses are not provided.

- LIN bus receiver

Please refer to the marking on SP209i casing for exact pinout.

RS485 receiver specifications

Transceiver MPN	MaxLinear XR33180
Maximum baudrate	50 Mbps
Common Mode Operating range	-7 V to +12 V
Common Mode Input Impedance	48 k Ω 10 pF
Common Mode voltage (absolute maximum)	± 15 V
Differential Threshold voltage	-125 mV
Differential Fixed hysteresis	25 mV
Differential Input Impedance	400 k Ω or 120 Ω Software selectable

RS232 receiver specifications

Transceiver MPN	Maxim MAX3180
Max. baudrate	1.5 Mbps
Operating range	± 15 V
Input Impedance	5 k Ω 50 pF
Absolute max voltage	± 20 V
Threshold voltage	1.5 V
Hysteresis	300 mV

CAN receiver specifications

Transceiver MPN	Microchip MCP2542
CAN FD compatible	Yes (11898-2:2015)
Max. baudrate	8 Mbps
Common Mode Operating range	± 12 V

Common Mode Input Impedance	6 to 50 k Ω 20pF
Common Mode Absolute max voltage	\pm 24 V
Differential Mode Operating range	-4 V to +9 V
Differential Threshold voltage	700 mV
Differential Fixed hysteresis	30 mV to 200 mV
Differential Input Impedance	25 k Ω 20 pF or 120 Ω Software selectable

LIN receiver specifications

Transceiver MPN	Infineon TLE7257
Main specification	ISO 17987-4
Max. baudrate	20 kbps
Operating range (BAT pin)	6 V to 18 V
Operating range (RX pin)	0 V to 18 V
RX pull up resistance (to BAT)	40 k Ω
Absolute max voltage (BAT)	\pm 24 V
Absolute max voltage (RX)	\pm 24 V
Threshold voltage	0.5 x VBAT
Hysteresis	0.12 x VBAT

Please note that SP209i can still only capture 9 channels simultaneously. Industrial inputs are internally multiplexed with logic inputs.

It is recommended to connect the ground of the industrial bus being measured to the nearest ground screw terminal (Refer to marking on SP209i casing for industrial connector pinout).

What's in the box

SP209 series is shipped with the following items:

1. SP209(i) device

2. USB cable (micro-B to A)
3. 10 leads micro-grabber probes set (9 signals + 1 ground)
4. 10 slots cable comb (to group logic probes together)
5. SMA anti-dust covers

Unpacking and first usage

We recommend the user to start by identifying all the different components that are provided. To turn ON the SP209 device, connect it to a free USB port of your computer using the provided USB cable⁵. The LED should glow according to the table in the “Status LEDs behavior” section. To switch off the device, simply disconnect the USB cable.

Status LEDs behavior

Status led can be in one of 3 states:

Status LED	Meaning
Orange	Device powered up but not connected to software
White Fix	Device powered up and connected to software
White blinking	Device powered up, connected to software and detecting activity on one of the logic channels.

Software Quick Start guide

Start by downloading the latest version of ScanaStudio software www.ikalogic.com and following instructions to install both software and provided drivers. It is recommended to restart your computer after the software and drivers have been installed.

Once the software is installed, run it, and create a new workspace by selecting “SP209” or “SP209i” as the device type.

Note: if at the point the device is not recognized by your computer, the ScanaStudio workspace is created as a demo workspace or the status LEDs stays orange even after creating a ScanaStudio workspace, please follow these steps:

⁵Do not connect SP209 to anything else than a computer’s USB port. Do not connect to a USB HUB, but connect directly to the root USB port. Never connect the SP209 to a USB charging adaptor.

- Ensure the USB port used can deliver at least 500mA.
- Try switching to another machine if one is available.
- If all of the above fails, please contact Ikalogic support.

Capturing your first signal

To capture your first logic signals, please follow these steps:

1. Connect the device via USB
2. Launch ScanaStudio and create an SP209(i) workspace.
3. Connect the probes to SP209(i) and to your signals source
4. Ensure the ground probe is connected
5. Check if the status LED is blinking: if it's the case, it means the some logic changes are already being detected on the probes.
6. Hit the start button in ScanaStudio and wait until signals are captured.

You can adjust the capture duration by adjusting the number of samples in the device configuration tab.

Mechanical data

All SP209 series devices casing are manufactured from anodized aluminum, able to withstand heavy duty usage in various harsh environments. All markings are laser engraved, ensuring important pinout information is not lost over time.

Model SP209i

Weight: 105 gm

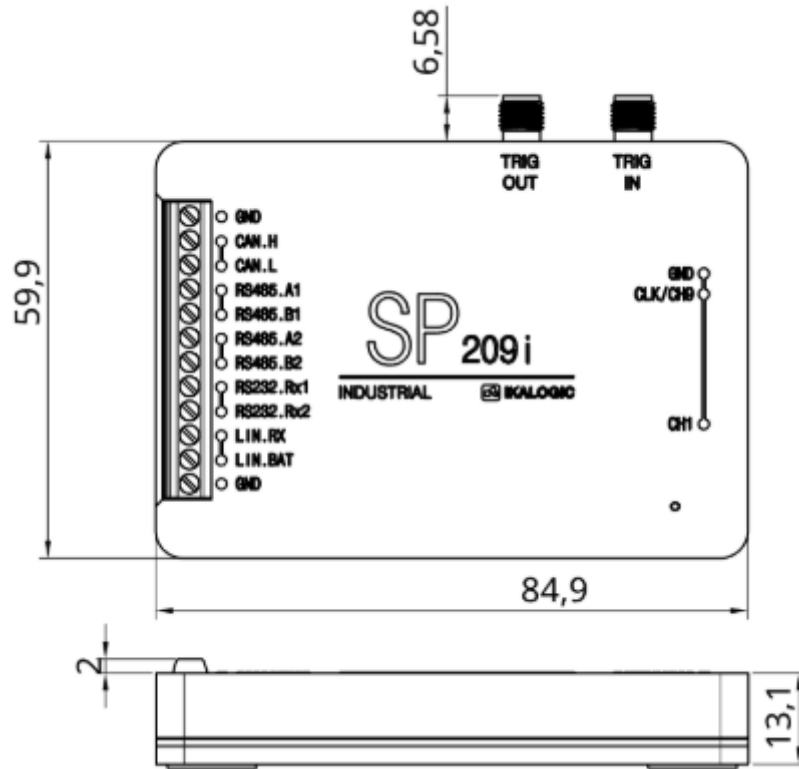

Figure 7: SP209i dimensions (mm)

Model SP209

Weight: 90 g

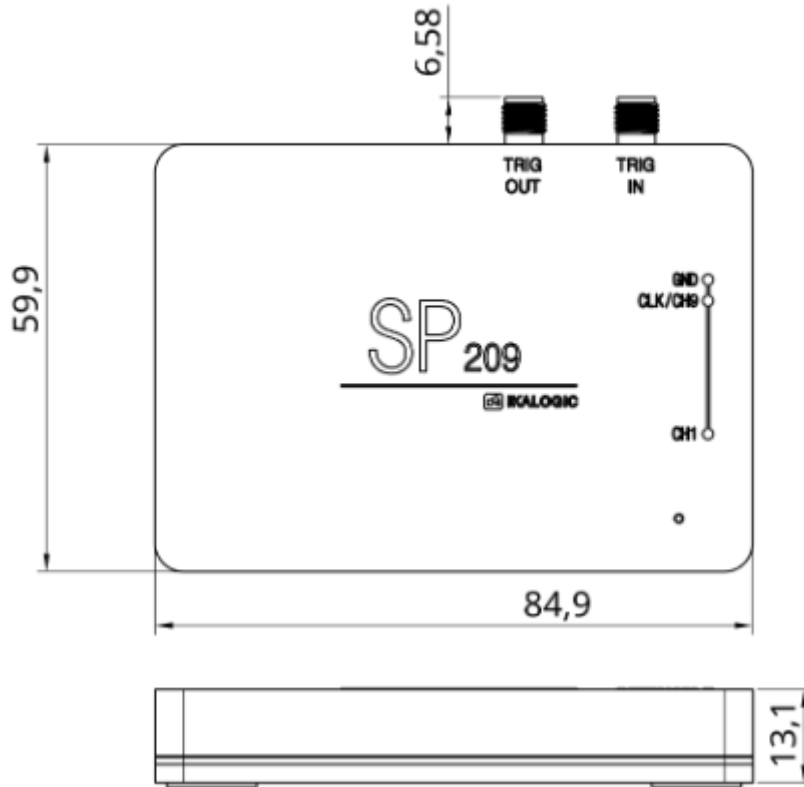

Figure 8: SP209 dimensions (mm)

Probes

Probes cables are made of 24AWG extra flexible silicone wires. All wires are black colored, but every wire has a white marking tube with the channel number (e.g. "1" or "GND") and a colored sticker on the probe tip.

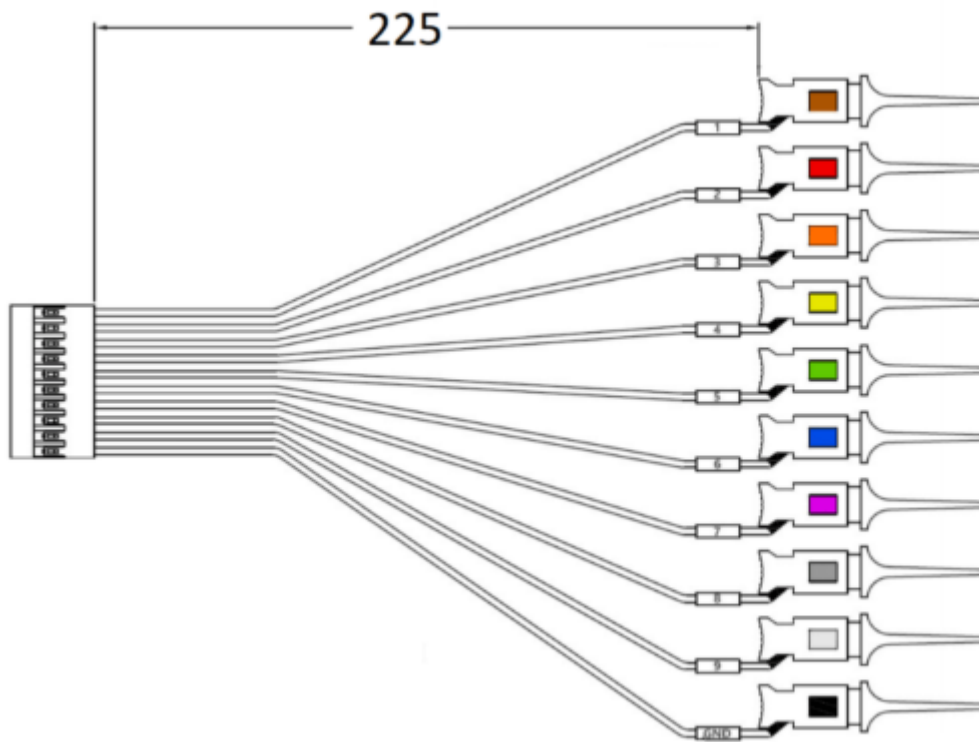

Figure 9: Probes dimensions (mm)

Software technical requirements

Download ScanaStudio software on www.ikalogic.com so you can use your device on your favorite platform. SP209(i) and ScanaStudio were tested to supports the following platforms:

- Windows 7/8/10
- Mac OS 10.9 or later
- Ubuntu 14.04 or later

Ordering information and customer support

For ordering information, please check for nearest distributor on www.ikalogic.com or contact us for any inquiry at contact@ikalogic.com.

Accessories and maintenance

Accessories and maintenance services (probes replacement) are available on our website: www.ikalogic.com or by contacting customer support (support@ikalogic.com).

Certifications and regulations

This device complies with the following applicable European Directives: Electromagnetic Compatibility (EMC) Directive 2004/108/EC, Low-Voltage Directive 2006/95/EC, IEC 61326-2.

This device complies with part 15 of the FCC Rules. Operation is subject to the following two conditions: (1) This device may not cause harmful interference, and (2) this device must accept any interference received, including interference that may cause undesired operation.

CAN ICES-3 (B) / NMB-3 (B)

RoHS Compliant 2011/65/EC. This device does not contain any of the substances in excess of the maximum concentration values (“MCVs”) defined in the EU RoHS Directive.

NOTE: This equipment has been tested and found to comply with the limits for a Class B digital device, pursuant to part 15 of the FCC Rules. These limits are designed to provide reasonable protection against harmful interference in a residential installation. This equipment generates uses and can radiate radio frequency energy and, if not installed and used in accordance with the instructions, may cause harmful interference to radio communications. However, there is no guarantee that interference will not occur

in a particular installation. If this equipment does cause harmful interference to radio or television reception which can be determined by turning the equipment off and on, the user is encouraged to try to correct the interference by one or more of the following measures:

- Reorient or relocate the receiving antenna.
- Increase the separation between the equipment and receiver.
- Connect the equipment into an outlet on a circuit different from that to which the receiver is connected.
- Consult the dealer or an experienced radio/TV technician for help.



Safety information

This product complies with safety standards IEC NF/EN 61010-1: 2010, IEC NF/EN 61010-2-030 and UL 61010-1: 2015 To prevent possible electrical shock, fire, personal injury, or damage to the product, read all safety information before you use the product. The following international symbols are used on the product and in this manual.

Symbols definitions



Figure 10: Risk of Danger. Important information. See Manual.



Figure 11: WEEE logo. This product complies with the WEEE Directive (2002/96/EC) marking requirements. The affixed label indicates that you must not discard this electrical/electronic product in domestic household waste. Product Category: With reference to the equipment types in the WEEE Directive Annex I, this product is classed as category 9 Do not dispose of this product as unsorted municipal waste.



Figure 12: CE Logo. Conforms to European Union directives.

Important safety notes



Warning, to avoid electrical shock or fire:

- Carefully read all instructions.
- Use the product only as specified, otherwise the protection supplied by the product can be compromised.

- Do not use the product if it operates incorrectly.
- Before use, inspect device casing, probes, test leads and accessories for mechanical damage and replace if damaged.
- Never attempt to repair a defective device. Contact after-sale service.
- Do not use the product or its accessories in case of any damage.
- Remove all probes, test leads and accessories that are not in use.
- Never use the device for measuring mains circuits.
- Never use the device for measuring circuits which are not isolated from mains.
- Do not touch electrical wires with bare hands.
- Keep away from children's sight or from animals.
- Do not expose to water, heat or moisture.
- The device's ground connection through the USB cable is for measurement purposes only. The logic analyzer does not have a protective safety ground.
- Ensure there is no significant voltage between device ground and the point to which you intend to connect it.
- Do not apply more than the rated voltage ($\pm 25V$), between the terminals or between each terminal and ground.
- Do not apply input voltages above the rating of the instrument ($\pm 25V$).
- Measure a known voltage first to make sure that the product operates correctly.
- Do not work alone.
- Comply with local and national safety codes. Use personal protective equipment (approved rubber gloves, face protection, and flame resistant clothes) to prevent shock.
- Do not use the device in wet or damp conditions, or around explosive gas or vapor.
- Do not operate the product with covers removed or the case open. Hazardous voltage exposure is possible.
- Do not use in a system in which the failure of the product might result in personal injury.

Limited warranty & limitation of liability

Each Ikalogic product is warranted to be free from defects in material and workmanship under normal use and service. The warranty period is three years for the test tool and two year for its accessories. This warranty extends only to the original buyer or end-user customer of an Ikalogic authorized reseller, and does not apply to fuses, disposable batteries or to any product which, in Ikalogic's opinion, has been misused, altered, neglected or damaged by accident or abnormal conditions of operation or handling.

THIS WARRANTY IS BUYER'S SOLE AND EXCLUSIVE REMEDY AND IS IN LIEU OF ALL OTHER WARRANTIES,

EXPRESS OR IMPLIED, INCLUDING BUT NOT LIMITED TO ANY IMPLIED WARRANTY OF MERCHANTABILITY OR FITNESS FOR A PARTICULAR PURPOSE. IKALOGIC SHALL NOT BE LIABLE FOR ANY SPECIAL, INDIRECT, INCIDENTAL OR CONSEQUENTIAL DAMAGES OR LOSSES, INCLUDING LOSS OF DATA, WHETHER ARISING FROM BREACH OF WARRANTY OR BASED ON CONTRACT, TORT, RELIANCE OR ANY OTHER THEORY. Since some countries or states do not allow limitation of the term of an implied warranty, or exclusion or limitation of incidental or consequential damages, the limitations and exclusions of this warranty may not apply to every buyer. If any provision of this Warranty is held invalid or unenforceable by a court of competent jurisdiction, such holding will not affect the validity or enforceability of any other provision.

Document Revisions

30-June-2019	Updated safety information section Added Ordering information and customer support section Added Accessories and maintenance section Added Limited warranty & limitation of liability section
04-February-2019	Added SP209i integrated transceivers Manufacturer Part Numbers Updated T.B.D. parameters for the SP209i CAN transceiver Added specifications related to the CAN and LIN transceivers Changed trigger output voltage high level from 5V to 3.3V
01-February-2019	Moved from preliminary to final release. Fixed spelling error in quick start section
22-November-2018	Fixed error in “What’s in the box” chapter. Updated trigger OUT and trigger IN specifications. Updated device weight.
10-October-2018	Initial release of this document.

The information in this document is subject to change without notice.