

# R&S® NRQ6 FREQUENCY SELECTIVE POWER SENSOR



A milestone in power measurements



Product Brochure  
Version 05.00

**ROHDE & SCHWARZ**

Make ideas real



# AT A GLANCE

The R&S®NRQ6 combines the accuracy of a power meter with excellent dynamic range. It performs extremely precise and fast power measurements down to  $-130$  dBm.

The R&S®NRQ6 is based on receiver technology and can perform band-limited power measurements – i.e. power measurements on a selected transmission channel – down to  $-130$  dBm. The R&S®NRQ6 delivers high-precision, high-speed measurements beyond the limits of currently available power meters.

In addition to conventional continuous average measurements, the R&S®NRQ6 has a trace display function and also performs ACLR measurements – a common mobile communications application. Using the optional R&S®NRQ6-K1 I/Q data interface, I/Q data can be downloaded from the power sensor to a PC for further analysis.

The R&S®NRQ6-K2 power servoing option enables a dedicated high-speed remote control channel for fast power servoing between an R&S®NRQ6 and an R&S®SGT100A RF vector RF source. This significantly improves the typical setting time via SCPI.

Using additionally the R&S®NRQ6-K3 phase coherent measurements option, complex phase coherent measurements can be carried out by configuring one master R&S®NRQ6 and one or multiple slave R&S®NRQ6.

The R&S®NRQ6 is controlled via LAN, requiring power over Ethernet (PoE+). The sensor's integrated web server makes it possible to operate the GUI without any extra software – all that is needed is a PC with a web browser. The intuitive GUI is well structured and easy to operate thanks to diverse autoset functions.

## LEARN MORE ABOUT FREQUENCY SELECTIVE POWER SENSORS



**Key facts**

- ▶ Frequency selective power measurements
- ▶ Frequency range: 50 MHz to 6 GHz
- ▶ Power measurement range: -130 dBm to +20 dBm
- ▶ Automatic frequency and bandwidth detection
- ▶ 100 MHz measurement bandwidth
- ▶ Continuous average, trace and ACLR measurements
- ▶ I/Q data capturing for RF vector signal analysis
- ▶ Fast power servoing with R&S®SGT100A
- ▶ Phase coherent measurements for low-power modulated signals

**BENEFITS****Diverse measurement functions**

▶ page 4

**Easy operation**

▶ page 6

**High measurement speed at lowest signal levels**

▶ page 9



R&amp;S®NRQ6 frequency selective power sensor

# DIVERSE MEASUREMENT FUNCTIONS

## Continuous average power measurements down to -130 dBm – precise and fast

Conventional diode power sensors reach their physical limits at approx. -70 dBm. Fast measurements degrade accuracy, especially at low power levels, since the noise content measured by these sensors is relatively high. As a result, either speed or accuracy has to be sacrificed.

The receiver based architecture of the R&S®NRQ6 eliminates this problem. This concept lowers measurement noise. In addition, the sensor's ability to perform band-limited measurements reduces the noise floor. These characteristics enable high-precision, high-speed measurements down to -130 dBm.

## I/Q data capturing for RF vector signal analysis

The R&S®NRQ6 can be used as a standalone RF frontend to capture vector-modulated I/Q signals.

With the optional R&S®NRQ6-K1 I/Q data interface, captured I/Q data can be read out using SCPI commands. The data is demodulated and analyzed using external software, e.g. R&S®VSE.

As of R&S®NRQ6 version 2.10 and R&S®VSE version 1.70, direct data acquisition and control is possible.

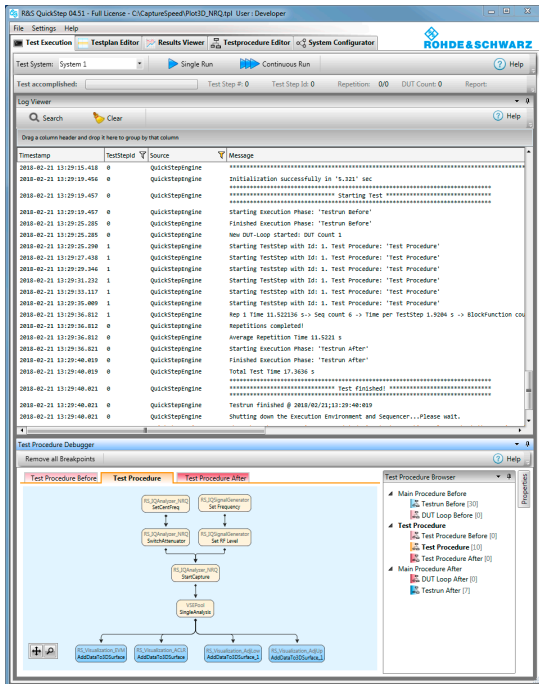

Signal analysis with R&S®QuickStep test executive software

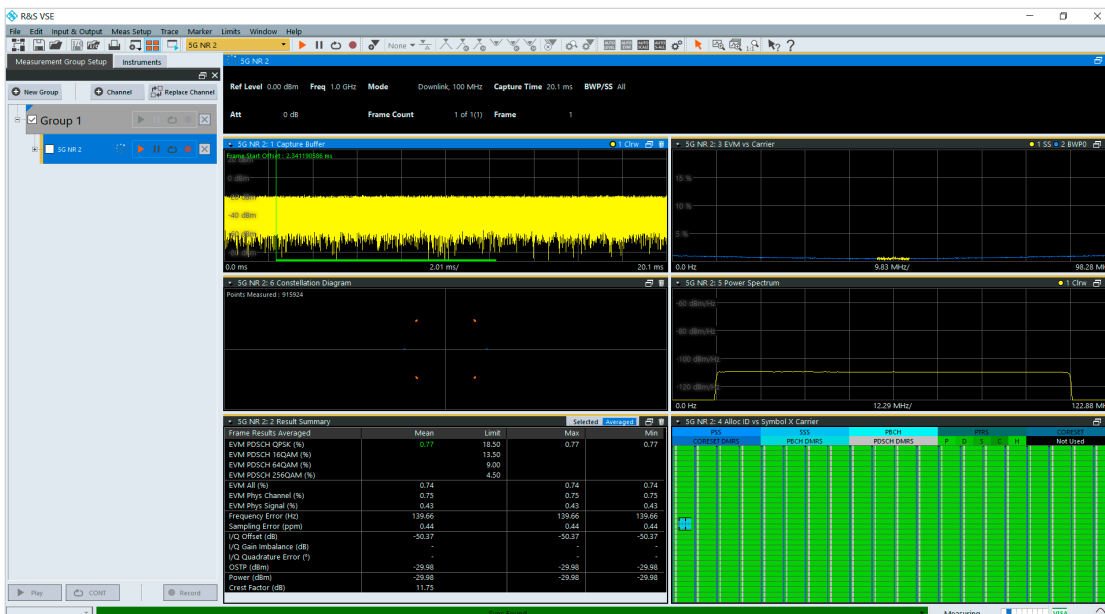

5G NR measurement with R&S®NRQ6 and R&S®VSE

Automated, cloud based data processing and analysis is also possible using the R&S®Quickstep test executive software to control any analysis tool in order to measure error vector magnitude (EVM), adjacent channel leakage ratio (ACLR) and other TX performance parameters.

### Remote spectrum monitoring and signal analysis with R&S®GSACSM

With the optional R&S®NRQ6-K1 I/Q data interface, the R&S®NRQ6 can be employed in the R&S®GSACSM communication system monitoring software for remote spectrum monitoring and signal analysis. This software solution comes with classic spectrum analyzer functions, trapping systems as well as advanced signal detection and identification algorithms. In a scalable client/server architecture, R&S®GSACSM allows remote spectrum analysis in distributed systems. Operators can therefore manage their instruments (e.g. R&S®NRQ6) in different locations.

### Trace measurements

A detailed trace display is necessary for precise analysis of short pulses. With an inherent rise/fall time of 13 ns at a resolution bandwidth of 50 MHz, for example, the R&S®NRQ6 can easily measure steep-edged pulses.

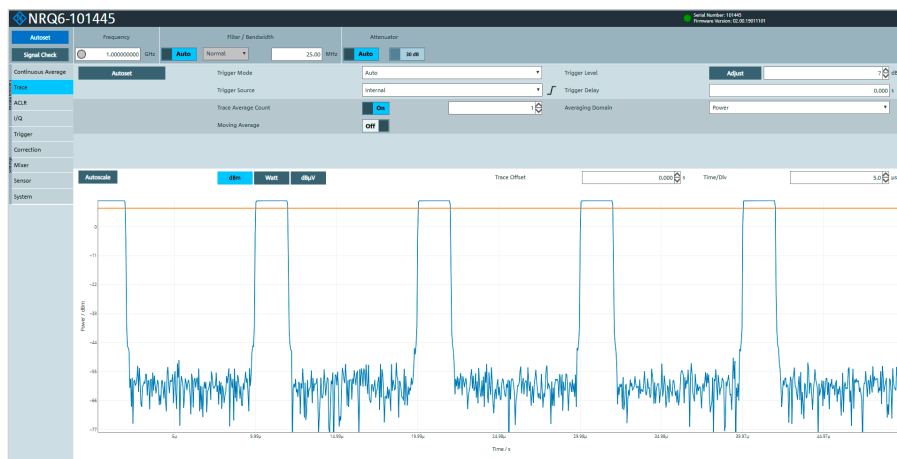

Trace measurement on a pulsed signal

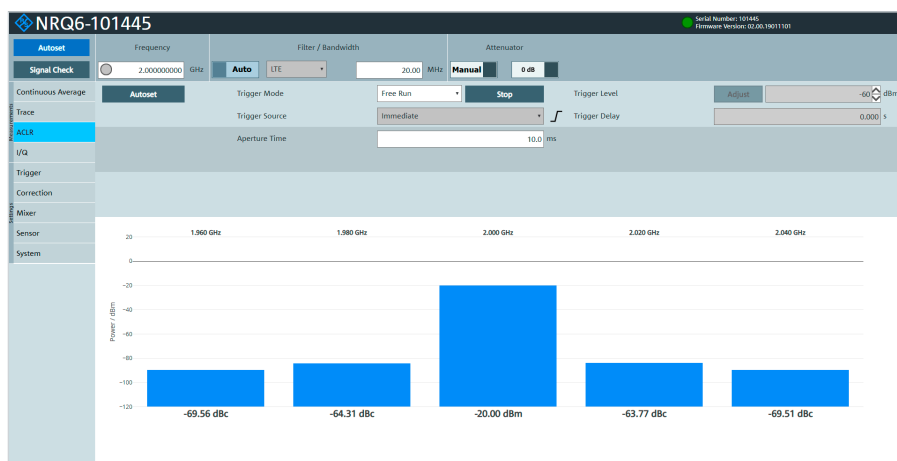

ACLR measurement on a 20 MHz LTE signal

### Ultrafast triggered measurements

Triggered measurements in particular call for ever higher measurement speeds over an extended period of time. The R&S®NRQ6 contains a powerful FPGA and a large memory to meet these requirements. More than 100 000 triggered readings can be stored in a buffer in 200 ms – corresponding to a measurement speed of 500 000 readings/s – and transferred to a control PC.

### Easy ACLR measurements

The frequency selective power sensor is perfect for adjacent channel leakage ratio (ACLR) measurements, which are frequently required in mobile communications. The ACLR measurement function is accessible from the web GUI and automatically sets one of the predefined 3GPP or LTE filters. The R&S®NRQ6 achieves an ACLR performance of typically -63 dBc for a 20 MHz LTE signal at -20 dBm.

# EASY OPERATION

## Intuitive web GUI

The R&S®NRQ6 is connected to the LAN via a PoE+ switch. The sensor includes an integrated web server. The intuitive web GUI can be operated from any web browser.

## Diverse autosest functions

Diverse autosest functions are available to simplify configuration of the main measurement parameters. The measurement frequency and signal bandwidth are automatically determined and set. As a result, even unknown signals are detected and average power is measured accurately.

Depending on the input level, the 30 dB RF input attenuator is automatically switched on or off to configure the optimal power measurement range.

The trace mode also offers autosest functions. For example, the time scale (x-axis) and the power scale (y-axis) can be optimally configured. A trigger is set automatically, ensuring stable display of the measured signal.



Rear view of the R&S®NRQ6 with hardware interfaces

## Automatic frequency tracking

A frequency tracker automatically sets the center frequency to facilitate measurements on narrowband signals with varying center frequency. This ensures that the measured signal is always within the selected measurement bandwidth.

## Spectrum display for signal check

Since power measurements are performed only in the set frequency range (defined by the center frequency and bandwidth), the settings must be checked to make sure they are correct. The signal check function provides a graphical display of the measured signal's spectrum and the set bandwidth. Users can see at a glance if the measured signal is within the set frequency range.

## Hardware interfaces for user convenience

The R&S®NRQ6 can be easily integrated into a test system. Remote operation is possible via LAN and USB.

The trigger I/O port can accept an external trigger signal or distribute an internally generated trigger signal to other R&S®NRQ6 power sensors.

An external LO signal can be fed to one of the R&S®NRQ6 power sensors, or the internal LO signal can be output and distributed to the other sensors.

The R&S®NRQ6 has a reference I/O port, e.g. for applying an external reference signal, and a sample clock I/O port.

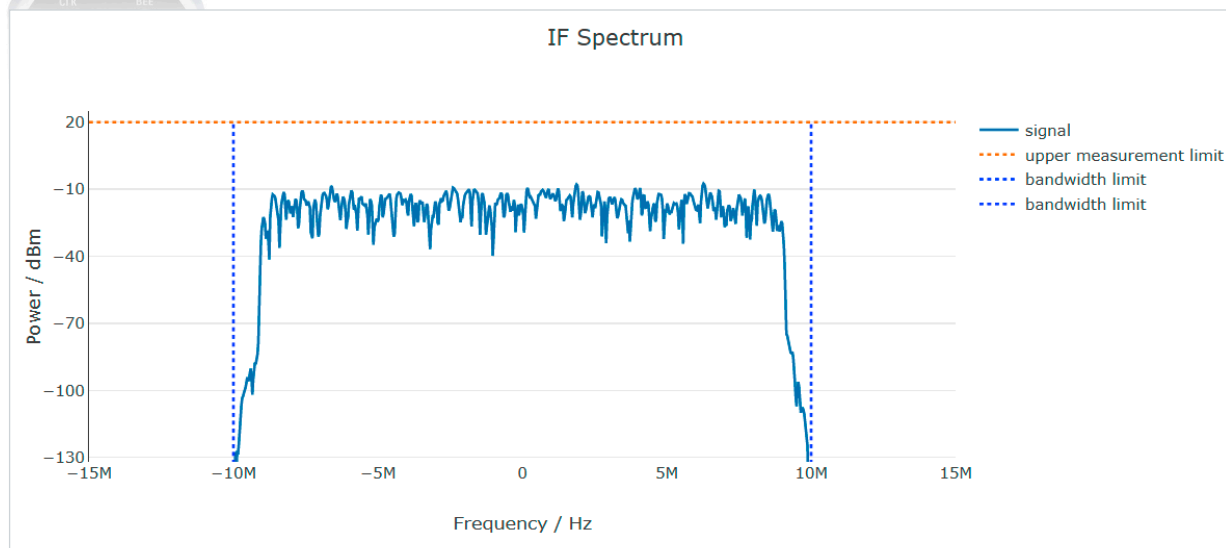

Signal check for a 20 MHz LTE signal

# APPLICATIONS

## TX power calibration

To calibrate a DUT's transmit power, it is necessary to measure the frequency response at higher levels and the linearity down to minimum levels. The R&S®NRQ6 performs both measurements. The sensor not only stands out due to its high-precision power measurements, it also features excellent linearity of 0.02 dB. The R&S®NRQ6 is a compact, single-device solution for calibrating transmit power. No additional instruments or components such as a splitter and spectrum analyzer are needed. The sensor can be directly connected to the DUT; no cable is required. This solution provides better stability, lower mismatch and higher accuracy.

## Band-limited power measurements on multistandard radios (MSR)

The R&S®NRQ6 can perform band-limited power measurements, i.e. it can measure the power on a selected transmission channel with a bandwidth up to 100 MHz, independent of neighboring channels. Band-limited power measurements can also be performed on base stations that support multiple mobile communications standards (MSR base stations), even if the user wants to measure only one standard.

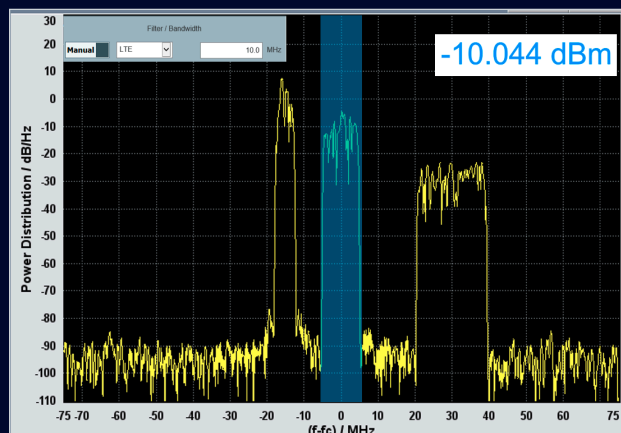

Single-channel power measurement on an MSR signal

## Fast power servoing with R&S®NRQ6 and R&S®SGT100A

In component test applications, non-linear DUT characteristics make it difficult to set a specific output power. Conventional solutions based on SCPI via Ethernet are limited in speed. It takes several iterations to reach the desired power level, so the typical set time is 10 ms. This may be not adequate for production purposes.

The R&S®NRQ6-K2 power servoing option enables a dedicated serial communications channel between R&S®NRQ6 and R&S®SGT100A via the trigger connectors. Using this high-speed remote control directly between the FPGAs bypasses the speed limits of SCPI over Ethernet. It typically takes 1 ms to 1.5 ms to set the desired power on the R&S®SGT100A.

The R&S®NRQ6 can additionally perform power measurements without disconnecting, simply by remote control commands. For maximum performance and speed in power servoing applications, the setup can be extended by additional equipment. In that case, the R&S®NRQ6 is dedicated to fast power servoing and the measurements are performed, e.g. with a spectrum analyzer (SPA) or a second R&S®NRQ6.

## Power servoing with R&S®NRQ6 and R&S®SGT100A

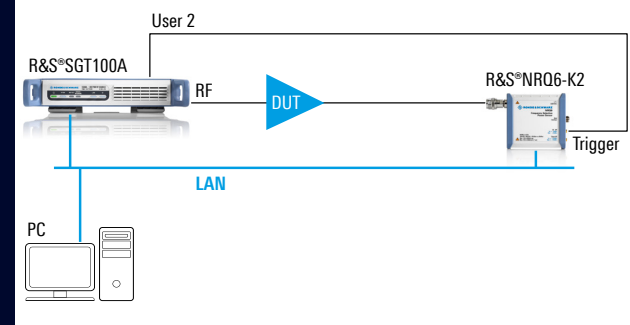

## Optional SPA for maximum performance and speed

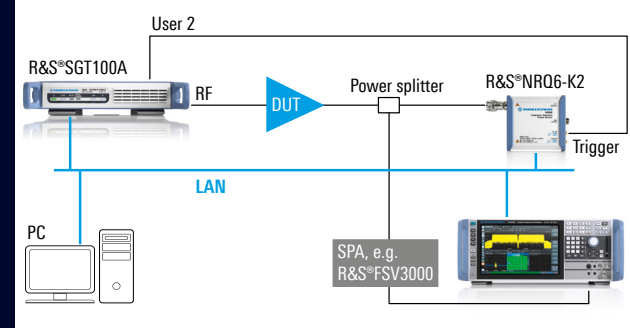

## Calibration of multiple active antenna modules for beamforming

The synchronous phase coherent measurements (R&S®NRQ6-K3 option) are based on a master/slave relationship between two or more R&S®NRQ6. The master forwards the local oscillator (LO) signal and its clock signal (CLK) to the slave(s) and triggers the slave(s). All measurement results are performed relative to the master. A calibration step before the first measurement helps eliminate the resulting group delay in the slave measurements. This is a simple and ideal solution for calibrating multiple active antenna modules for beamforming applications.

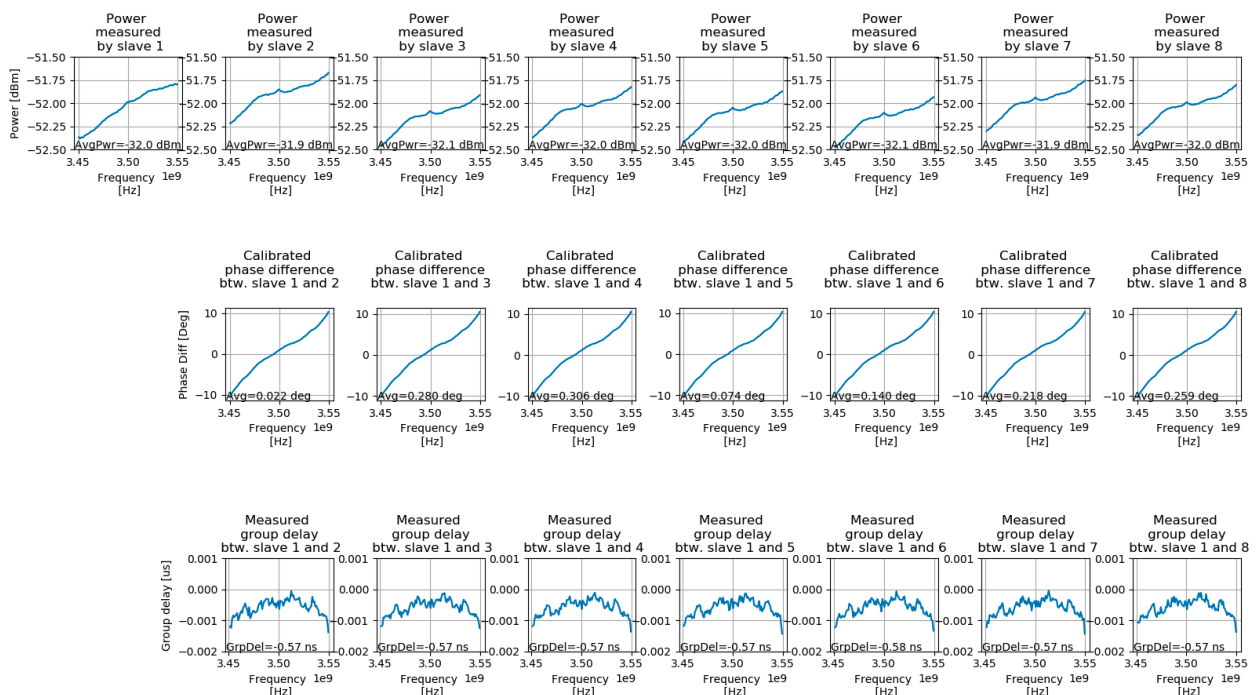

Results of an example multichannel phase difference measurement with one R&S®NRQ6 as master and eight R&S®NRQ6 as slaves.

The master R&S®NRQ6 is only used for distribution of TRG, CLK and LO signals.



# HIGH MEASUREMENT SPEED AT LOWEST SIGNAL LEVELS

Every diode based power meter works without band limitation in the specified frequency range. This feature makes the sensors very flexible, but has a significant impact: the noise contribution. Precise measurement of low-power signals requires averaging of multiple measurement samples and this increases the measurement time. The diode based power meter technology is mature, and therefore only limited product innovations are possible.

Precise and fast measurement of very low-power signals below  $-30$  dBm was not possible until now. The receiver technology based R&S®NRO6 has significantly increased the measurement speed for low-power signals.

Compared with R&S®NRP8S, the R&S®NRO6 reduces the measurement time by a factor of approx. 20000 for a CW signal with a power level of  $-50$  dBm and noise contribution of  $0.01$  dB.

## Comparison of measurement time for a CW signal

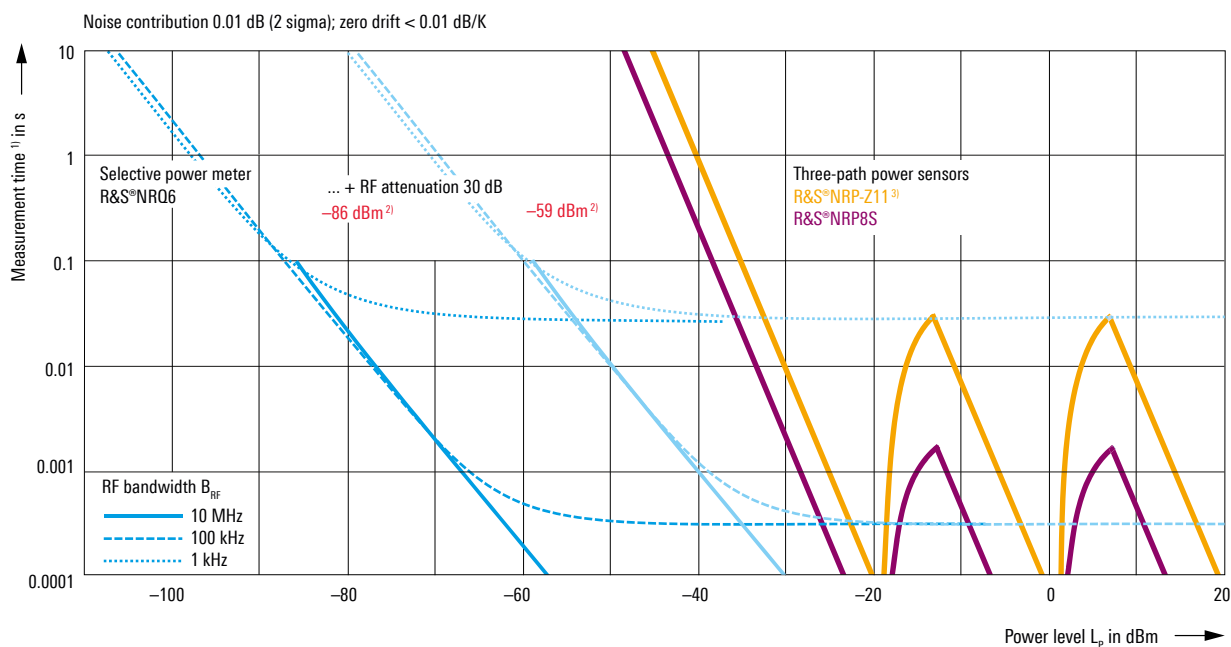

<sup>1)</sup> Measurement time: integration time + RF filter settling time.

<sup>2)</sup> Lower measurement limit for  $RBW = 10$  MHz.

<sup>3)</sup> The discontinued R&S®NRP-Z11 is the direct predecessor of the R&S®NRP8S.

# SPECIFICATIONS

## Definitions

### General

Product data applies under the following conditions:

- ▶ Three hours storage at ambient temperature followed by 30 minutes warm-up operation
- ▶ Specified environmental conditions met
- ▶ Recommended calibration interval adhered to
- ▶ All internal automatic adjustments performed, if applicable

### Specifications with limits

Represent warranted product performance by means of a range of values for the specified parameter. These specifications are marked with limiting symbols such as  $<$ ,  $\leq$ ,  $>$ ,  $\geq$ ,  $\pm$ , or descriptions such as maximum, limit of, minimum. Compliance is ensured by testing or is derived from the design. Test limits are narrowed by guard bands to take into account measurement uncertainties, drift and aging, if applicable.

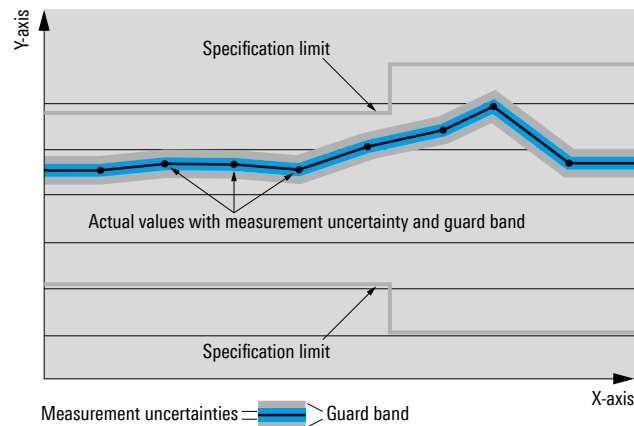

### Specifications without limits

Represent warranted product performance for the specified parameter. These specifications are not specially marked and represent values with no or negligible deviations from the given value (e.g. dimensions or resolution of a setting parameter). Compliance is ensured by design.

### Typical data (typ.)

Characterizes product performance by means of representative information for the given parameter. When marked with  $<$ ,  $>$  or as a range, it represents the performance met by approximately 80% of the instruments at production time. Otherwise, it represents the mean value.

### Nominal values (nom.)

Characterize product performance by means of a representative value for the given parameter (e.g. nominal impedance). In contrast to typical data, a statistical evaluation does not take place and the parameter is not tested during production.

### Measured values (meas.)

Characterize expected product performance by means of measurement results gained from individual samples.

### Uncertainties

Represent limits of measurement uncertainty for a given measurand. Uncertainty is defined with a coverage factor of 2 and has been calculated in line with the rules of the Guide to the Expression of Uncertainty in Measurement (GUM), taking into account environmental conditions, aging, wear and tear.

Device settings and GUI parameters are indicated as follows: "parameter: value".

Typical data as well as nominal and measured values are not warranted by Rohde&Schwarz.

In line with the 3GPP/3GPP2 standard, chip rates are specified in million chips per second (Mcps), whereas bit rates and symbol rates are specified in billion bits per second (Gbps), million bits per second (Mbps), thousand bits per second (kbps), million symbols per second (MSPS) or thousand symbols per second (kSPS), and sample rates are specified in million samples per second (Msamples/s). Gbps, Mcps, Mbps, MSPS, kbps, kSPS and Msamples/s are not SI units.

## R&amp;S®NRQ6 power sensor signal flow from RF input connector to result processing

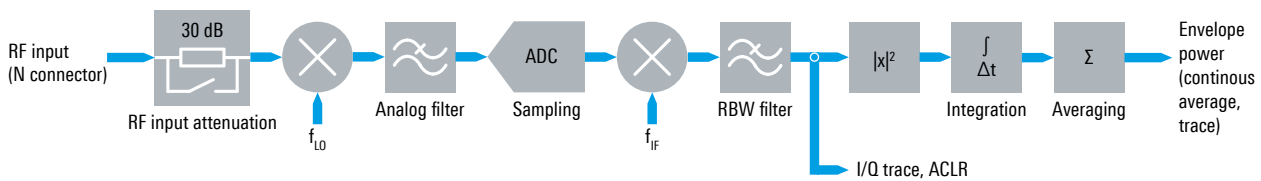

## Specifications

<b>Frequency range</b>	50 MHz to 6.0 GHz			
<b>Impedance matching (SWR)</b>	50 MHz to 100 MHz	< 1.20		
	> 100 MHz to 2.0 GHz	< 1.13		
	> 2.0 GHz to 6.0 GHz	< 1.20		
<b>Power measurement range</b>	dynamic range dependent on RBW (10 Hz to 400 MHz)	-130 dBm to +20 dBm		
<b>Damage level</b>	max. average power	1 W (+30 dBm) continuous		
	max. peak envelope power	2 W (+33 dBm) for max. 1 μs		
	max. DC voltage	± 20 V		
<b>RF input attenuation</b>	0 dB, 30 dB			
<b>Measurement subranges</b>	RF input attenuation = 0 dB	-130 dBm to -10 dBm		
	RF input attenuation = 30 dB	-100 dBm to +20 dBm		
<b>Resolution bandwidth (RBW)<sup>1)</sup></b>	single-sideband (SSB) mode	10 Hz to 40 MHz		
	zero IF mode (RF input frequency ≥ 400 MHz)	50 MHz, 80 MHz, 100 MHz, 400 MHz		
<b>Acquisition</b>	sample rate	119 MHz to 121 MHz <sup>2)</sup>		
<b>Displayed average noise level (DANL)<sup>3)</sup></b>	RF input attenuation = 0 dB			
	50 MHz to 100 MHz	< -148 dBm (1 Hz)		
	> 100 MHz to 400 MHz	< -153 dBm (1 Hz)		
	> 400 MHz to 2.4 GHz	< -156 dBm (1 Hz)		
	> 2.4 GHz to 6.0 GHz	< -153 dBm (1 Hz)		
	RF input attenuation = 30 dB			
	50 MHz to 100 MHz	< -118 dBm (1 Hz)		
	> 100 MHz to 400 MHz	< -123 dBm (1 Hz)		
	> 400 MHz to 2.4 GHz	< -126 dBm (1 Hz)		
	> 2.4 GHz to 6.0 GHz	< -121 dBm (1 Hz)		
<b>Uncertainty for absolute power measurements<sup>4)</sup></b>	operating temperature range			
		+20°C to +25°C	+15°C to +35°C	0°C to +50°C
	RF input attenuation = 0 dB			
	50 MHz to 100 MHz	0.156 dB	0.167 dB	0.211 dB
	> 100 MHz to 400 MHz	0.130 dB	0.143 dB	0.192 dB
	> 400 MHz to 3 GHz	0.080 dB	0.100 dB	0.163 dB
	> 3 GHz to 6 GHz	0.092 dB	0.110 dB	0.169 dB
	RF input attenuation = 30 dB			
	50 MHz to 100 MHz	0.176 dB	0.189 dB	0.237 dB
	> 100 MHz to 400 MHz	0.147 dB	0.162 dB	0.216 dB
	> 400 MHz to 3 GHz	0.093 dB	0.114 dB	0.183 dB
	> 3 GHz to 6 GHz	0.105 dB	0.125 dB	0.190 dB
<b>Uncertainty for relative power measurements<sup>5)</sup> between any two power levels</b>	RF input attenuation = 0 dB			
	-60 dBm to -20 dBm	0.020 dB		
	RF input attenuation = 30 dB			
	-30 dBm to +10 dBm	0.020 dB		

Specifications				
<b>Internal reference frequency</b>	accuracy	$\pm 1 \times 10^{-6}$		
<b>Intermediate frequency (IF)</b>	RBW $\leq 40$ MHz	20 MHz to 30 MHz <sup>6)</sup>		
	RBW $\geq 50$ MHz	zero IF		
<b>IF flatness</b>	operating temperature range	+20°C to +25°C	+15°C to +35°C	0°C to +50°C
	▶ RF input frequency $\geq 400$ MHz			
	▶ RBW $\leq 40$ MHz			
	▶ RBW filter type: flat	typ. $< \pm 0.02$ dB	typ. $< \pm 0.03$ dB	typ. $< \pm 0.08$ dB
	▶ offset from center frequency $\leq \pm 0.4$ RBW			
<b>Image response</b>	operating temperature range	+20°C to +25°C	+15°C to +35°C	0°C to +50°C
	50 MHz to 100 MHz	typ. $< -30$ dBc	typ. $< -30$ dBc	typ. $< -25$ dBc
	> 100 MHz to 400 MHz	typ. $< -45$ dBc	typ. $< -40$ dBc	typ. $< -35$ dBc
	> 400 MHz to 6 GHz	typ. $< -50$ dBc	typ. $< -45$ dBc	typ. $< -40$ dBc
<b>Spurious response at LO harmonics<sup>7)</sup></b>	$2 \times f_{LO} \pm f_{IF}$	meas. $-30$ dB		
	$3 \times f_{LO} \pm f_{IF}$	meas. $-9$ dB		
	$4 \times f_{LO} \pm f_{IF}$	meas. $-32$ dB		
	$5 \times f_{LO} \pm f_{IF}$	meas. $-14$ dB		
<b>LO phase noise</b>	at 1 kHz offset, measurement bandwidth 1 Hz, measured at LO I/O connector			
	400 MHz	typ. $< -98$ dBc		
	1 GHz	typ. $< -92$ dBc		
	2 GHz	typ. $< -86$ dBc		
	4 GHz	typ. $< -80$ dBc		
	6 GHz	typ. $< -74$ dBc		
<b>LO leakage at RF input connector (LO frequency and frequencies of harmonics)</b>				
RF input attenuation = 0 dB				
	$f < 3$ GHz	typ. $< -55$ dBm		
	$3 \text{ GHz} \leq f \leq 6 \text{ GHz}$	typ. $< -45$ dBm		
RF input attenuation = 30 dB				
	$f < 3$ GHz	typ. $< -75$ dBm		
	$3 \text{ GHz} \leq f \leq 6 \text{ GHz}$	typ. $< -65$ dBm		

### Typical spurious response of the R&S®NRQ6 (at $f_{in} = 1.0$ GHz, RBW = 20 MHz and right IF sideband)

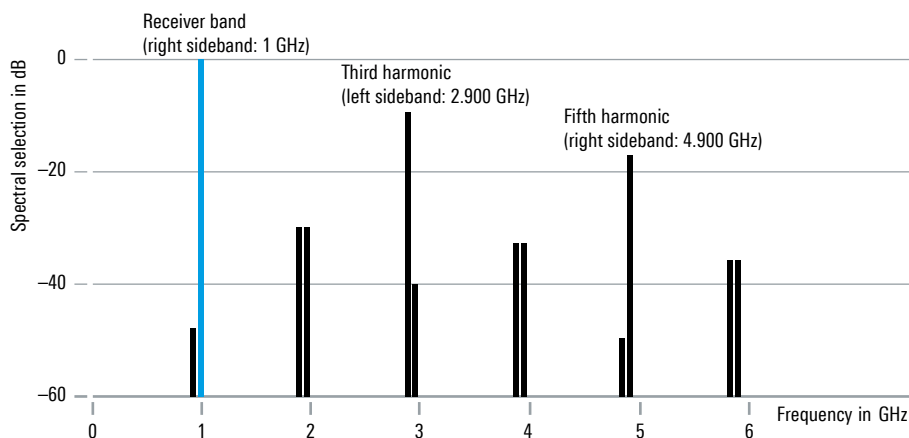

## Specifications

### Third-order intercept point (TOI)<sup>9)</sup>

	RF input attenuation = 0 dB	
	400 MHz	typ. > +13 dBm
	1 GHz	typ. > +12 dBm
	2 GHz	typ. > +10 dBm
	4 GHz	typ. > +8 dBm
	6 GHz	typ. > +5 dBm
	RF input attenuation = 30 dB	
	400 MHz	typ. > +43 dBm
	1 GHz	typ. > +42 dBm
	2 GHz	typ. > +40 dBm
	4 GHz	typ. > +38 dBm
	6 GHz	typ. > +35 dBm

### Second harmonic intercept point (SHI)

	RF input attenuation = 0 dB	
	1 GHz	typ. > +45 dBm
	2 GHz	typ. > +38 dBm
	4 GHz	typ. > +30 dBm
	6 GHz	typ. > +25 dBm
	RF input attenuation = 30 dB	
	1 GHz	typ. > +70 dBm
	2 GHz	typ. > +63 dBm
	4 GHz	typ. > +55 dBm
	6 GHz	typ. > +50 dBm

## Other characteristics

<b>Measurand</b>		power of incident wave power of source (DUT) into 50 Ω										
<b>RF input connector</b>		N (male)										
<b>Measurement functions</b>		<ul style="list-style-type: none"> <li>▶ continuous average</li> <li>▶ trace</li> <li>▶ adjacent channel leakage ratio (ACLR)</li> <li>▶ I/Q trace</li> </ul>										
<b>Continuous average function</b>	measurand	average power over acquisition interval										
	aperture	8.3 ns to 30 s (depending on RBW)										
	duty cycle correction <sup>9)</sup>	0.001 % to 100.0 %										
	capacity of measurement buffer <sup>10)</sup>	1 reading to 8192 readings										
<b>Trace function</b>	measurand	average power over pixel(s)										
	acquisition											
	length	8.3 ns to 30 s (depending on RBW)										
	trace offset	-15.0 s to +15.0 s (depending on RBW)										
	result											
	number of pixels	1 to 1048576										
	resolution	≥ 8.3 ns (sample period depending on RBW)										
<b>Adjacent channel leakage ratio (ACLR)</b>	measurand	power ratio										
	supported standards	<ul style="list-style-type: none"> <li>▶ 3GPP (3.84 MHz)</li> <li>▶ EUTRA/LTE (5 MHz, 10 MHz, 15 MHz, 20 MHz)</li> </ul>										
	acquisition length	1 ms to 40 ms										
	dynamic range	<table border="1" style="width: 100%; border-collapse: collapse;"> <thead> <tr> <th>test model</th> <th>level = -20 dBm, carrier frequency = 2 GHz</th> </tr> </thead> <tbody> <tr> <td>3GPP FDD, test model 1, 64 DPCH</td> <td>-69 dBc (meas.)<sup>11)</sup></td> </tr> <tr> <td>EUTRA/LTE 5 MHz</td> <td>-68 dBc (meas.)<sup>11)</sup></td> </tr> <tr> <td>EUTRA/LTE 10 MHz</td> <td>-65 dBc (meas.)<sup>11)</sup></td> </tr> <tr> <td>EUTRA/LTE 20 MHz</td> <td>-63 dBc (meas.)<sup>11)</sup></td> </tr> </tbody> </table>	test model	level = -20 dBm, carrier frequency = 2 GHz	3GPP FDD, test model 1, 64 DPCH	-69 dBc (meas.) <sup>11)</sup>	EUTRA/LTE 5 MHz	-68 dBc (meas.) <sup>11)</sup>	EUTRA/LTE 10 MHz	-65 dBc (meas.) <sup>11)</sup>	EUTRA/LTE 20 MHz	-63 dBc (meas.) <sup>11)</sup>
test model	level = -20 dBm, carrier frequency = 2 GHz											
3GPP FDD, test model 1, 64 DPCH	-69 dBc (meas.) <sup>11)</sup>											
EUTRA/LTE 5 MHz	-68 dBc (meas.) <sup>11)</sup>											
EUTRA/LTE 10 MHz	-65 dBc (meas.) <sup>11)</sup>											
EUTRA/LTE 20 MHz	-63 dBc (meas.) <sup>11)</sup>											

### R&S®NRQ6 ALCR performance at 2 GHz over power; EUTRA/LTE 20 MHz (meas., noise correction on)

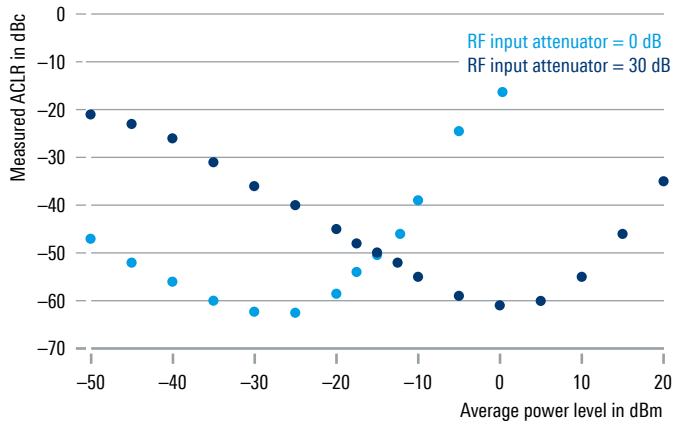

#### Other characteristics

<b>Phase coherent measurements</b>	measurand	standard deviation of 10 consecutive phase differences between two slave R&S®NRQ6	
	supported standards	5G NR, LTE, MCCW, CW	
		MCCW signal level	
		temperature: +20°C	
		signal bandwidth: 100 MHz	
		number of carriers: 100	
		carrier spacing: 1 MHz	
		center frequency: 3.5 GHz	
		-50 dBm	< 0.05° (meas.)
		-60 dBm	< 0.08° (meas.)
		-70 dBm	< 0.16° (meas.)
		-80 dBm	< 0.40° (meas.)
<b>I/Q trace function</b>	measurand	I/Q complex voltage	
	prerequisite	R&S®NRQ6-K1 option	
	result		
	output sample rate	100 Hz to 120 MHz (continuously variable, impacts effective RBW)	
	number of I/Q pairs	1 to 15000000	
<b>Power servoing with R&amp;S®SGT100A</b>	tolerance	0.01 dB to 3 dB	
	R&S®SGT100A firmware ≥4.65	sensor aperture time	10 μs to 100 ms
		setting time	typ. < 1.5 ms (tolerance = 0.1 dB, aperture = 100 μs, remote control via instrument driver)
	level tracking interval	500 ms	
<b>Triggering</b>	supported measurement functions	continuous average, trace, I/Q trace	
	source	<ul style="list-style-type: none"> <li>▶ INTernal: internal test signal</li> <li>▶ EXTernal2: coaxial trigger I/O (SMA (f) jack)</li> <li>▶ EXTernal[1]: host interface trigger signal (8-pin male M12 connector)</li> <li>▶ BUS: remote control event (*trg)</li> </ul>	
	dropout	0 s to 10 s (depending on RBW)	
	slope (external, internal)	positive/negative	
	delay	-5 s to +10 s <sup>12)</sup> (depending on RBW)	
	hold-off	0 s to 10 s (depending on RBW)	
	resolution (delay, hold-off, dropout)	≥ 8.3 ns (depending on RBW)	
	INTernal trigger threshold level		
	range	-110 dBm to +20 dBm	
	accuracy	identical to uncertainty for absolute power measurements	
	hysteresis	0 dB to 10 dB	
	trigger jitter	<ul style="list-style-type: none"> <li>▶ internal trigger: ≥ 8.3 ns (depending on RBW)</li> <li>▶ external trigger: 8.3 ns</li> </ul>	

## Other characteristics

<b>Averaging filter</b>	parameters	
	supported measurement functions	continuous average, trace
	averaging count	1 to 65 536
	result output	
	moving mode	continuous result output, independent of averaging count
	repeat mode	final result only
<b>RF input attenuation correction</b>	function	corrects the measurement result using a fixed factor (dB offset)
	range	-200 dB to +200 dB
<b>Host interface (8-pin male M12 connector)</b>		
▶ USB interface to PC via R&S®NRP-ZKU interface cable (requires additional PoE+ power supply at LAN interface)		
▶ USB interface to PC via R&S®NRP-ZK6 interface cable + R&S®NRP-Z5 USB sensor hub (requires additional PoE+ power supply at LAN interface)		
	mechanical	8-pin male M12 connector (A-coded)
	power supply	+5 V/0.1 A (USB low-power device; requires additional PoE+ power supply)
	speed	high-speed and full-speed mode in line with USB specification
	remote control protocols	USB test and measurement class (USBTMC)
	trigger input EXTERNAL[1]	differential (0 V/+3.3 V)
	reference clock	
	signal level	LVDS
	input frequency	20 MHz
	permissible total cable length	≤ 5 m
<b>Ethernet interface (LAN PoE+)</b>	mechanical	RJ-45 jack
	power supply	power over Ethernet (PoE+) class 4
	speed	10/100/1000 Mbit/s
	remote control protocols	VXI-11, HiSLIP (high-speed LAN instrument protocol), SCPI-RAW (port 5025)
	permissible cable length	≤ 100 m
<b>Trigger 2 I/O (TRIG2)</b>	mechanical	SMA (f) jack
	impedance	
	input	10 kΩ or 50 Ω (software controlled)
	output	50 Ω
	signal level	
	input	compatible with 3 V or 5 V logic, max. -1 V to +6 V
	output	≥ 2 V into 50 Ω load, max. 5.3 V
<b>Reference I/O (REF)</b>	mechanical	SMA (f) jack
	impedance	
	input/output	50 Ω
	signal level	
	input	≥ -10 dBm
	output	≥ +7 dBm
	frequency	
	input	10 MHz
	output	10 MHz
<b>Clock I/O (CLK)</b>	mechanical	SMA (f) jack
	impedance	
	input/output	50 Ω
	signal level	
	output	≥ -10 dBm
	frequency	
	output	119 MHz to 121 MHz

**Other characteristics**

<b>Local oscillator I/O (LO)</b>	mechanical	SMA (f) jack
	impedance	
	input/output	50 $\Omega$
	signal level	
	input	$\geq -5$ dBm
	output	$\geq 0$ dBm
	frequency	
	input/output	70 MHz to 6.03 GHz

**General data**

<b>Rated power</b>		19 W (meas.)
<b>Temperature ranges</b> <sup>13)</sup>	operating temperature range	0°C to +50°C
	storage temperature range	-40°C to +85°C
<b>Climatic resistance</b>	damp heat	+25°C/+55°C cyclic at 95% relative humidity with restrictions: noncondensing, in line with EN 60068-2-30
<b>Mechanical resistance</b>	vibration	
	sinusoidal	5 Hz to 55 Hz, 0.15 mm amplitude, 1.8 g at 55 Hz, 55 Hz to 150 Hz, 0.5 g constant, in line with EN 60068-2-6
	random	8 Hz to 650 Hz, 1.9 g (RMS), in line with EN 60068-2-64
	shock	45 Hz to 2 kHz, max. 40 g shock spectrum, in line with MIL-STD-810E, method 516.4, procedure I
<b>Air pressure</b>	operating	795 hPa (2000 m) to 1060 hPa
	transport	566 hPa (4500 m) to 1060 hPa
<b>Electromagnetic compatibility</b>		harmonized standards complied with: ▶ EN 61326-1 ▶ EN 61326-2-1 ▶ EN 55011 (class B)
<b>Calibration interval</b>	recommended	2 years
<b>Dimensions</b>	W x H x D	98 mm x 47 mm x 146 mm (3.85 in x 1.85 in x 5.75 in)
<b>Weight</b>		0.50 kg (1.10 lb)



- <sup>1)</sup> By default, the discrete RBW filter selection mode (1, 2, 3, 5, ... steps) is active. Alternatively, steplessly variable RBW can be activated for  $RBW \leq 20$  MHz. The SNR in the variable RBW selection mode may be slightly lower than in the discrete RBW selection mode.
- <sup>2)</sup> The sample rate is selected automatically.
- <sup>3)</sup> This applies to resolution bandwidths  $\leq 300$  kHz. For larger RBWs, spurious frequency response contributions might violate these limits at certain RF input frequencies. In addition, RBWs using zero IF mode might violate these limits due to DC offset contributions.
- <sup>4)</sup> Expanded uncertainty ( $k = 2$ ) for absolute continuous average power measurements on CW signals centered within  $RBWs \leq 10$  MHz. Specifications include calibration uncertainty, aging, linearity and temperature effect.  
Measurement noise must additionally be taken into account when measuring low powers. The contribution of measurement noise can be neglected below a two-sigma value of 0.01 dB.  
For signal power levels less than 30 dB above the DANL at the selected RBW, a measurement bias must additionally be taken into account.  
For power levels above +15 dBm/-15 dBm for 30 dB/0 dB RF input attenuation, respectively, uncertainty contributions due to intermodulation and other nonlinear effects must additionally be taken into account.  
For RBWs below 1 kHz, LO phase noise contributions must additionally be taken into account.  
For RBWs above 300 kHz, uncertainty contributions due to coherent spurious response frequencies (e.g. when a locked reference frequency is used) must additionally be taken into account.  
When configuring the power sensor for use with an externally supplied LO signal, uncertainty contributions due to the signal integrity of the external LO signal must additionally be taken into account. Signal integrity includes properties such as frequency accuracy, and amplitude and phase stability.
- <sup>5)</sup> Expanded uncertainty ( $k = 2$ ) for relative power measurements on CW signals of identical frequency in continuous average mode for  $RBW \leq 10$  MHz. Specifications include aging and temperature effect.  
Measurement noise must additionally be taken into account.  
For signal power levels less than 30 dB above the DANL at the selected RBW, a measurement bias must additionally be taken into account.  
For RBWs below 1 kHz, LO phase noise contributions must additionally be taken into account.  
For RBWs above 300 kHz, uncertainty contributions due to coherent spurious response frequencies (e.g. when a locked reference frequency is used) must additionally be taken into account.  
When configuring the power sensor for use with an externally supplied LO signal, uncertainty contributions due to the signal integrity of the external LO signal must additionally be taken into account. Signal integrity includes properties such as frequency accuracy, and amplitude and phase stability.
- <sup>6)</sup> The IF frequency is selected automatically.
- <sup>7)</sup> The hardware design of the R&S®NRQ6 differs fundamentally from a spectrum analyzer. Therefore, the R&S®NRQ6 cannot provide a similar level of spurious response rejection (lower spurious response rejection at input frequency setting from 50 MHz to 300 MHz; increasingly higher spurious response rejection in the frequency range above 8 GHz). See user manual for details.
- <sup>8)</sup> Measurements were performed using two-tone signals separated by 2 MHz.
- <sup>9)</sup> For average power measurements of periodic bursts.
- <sup>10)</sup> To increase measurement speed, the power sensor can be operated in buffered mode. In this mode, measurement results are stored in a buffer of user-definable size and output as a data block when the buffer is full. For further information, see application sheet "R&S®NRQ6. Fast Pulse Power Measurement" (1178824202).
- <sup>11)</sup> Noise correction improves the ACLR by typ. 5 dB, depending on the level and bandwidth.
- <sup>12)</sup> In I/Q trace mode, only positive trigger delays are supported.
- <sup>13)</sup> The operating temperature range defines the span of ambient temperature in which the instrument complies with specifications.

# ORDERING INFORMATION

Designation	Type	Order No.
Frequency selective power sensor	R&S®NRQ6	1421.3509.02
I/Q data interface	R&S®NRQ6-K1	1421.4705.02
Power servoing	R&S®NRQ6-K2	1421.4740.02
Phase coherent measurements	R&S®NRQ6-K3	1421.4770.02
<b>Accessories</b>		
Ten-port PoE+ switch	R&S®NRP-ZAP2	3639.1902.02
USB interface cable, length: 0.75 m	R&S®NRP-ZKU	1419.0658.02
USB interface cable, length: 1.50 m	R&S®NRP-ZKU	1419.0658.03
USB interface cable, length: 3.00 m	R&S®NRP-ZKU	1419.0658.04
USB interface cable, length: 5.00 m	R&S®NRP-ZKU	1419.0658.05
Six-pole interface cable, length: 1.50 m	R&S®NRP-ZK6	1419.0664.02
Six-pole interface cable, length: 3.00 m	R&S®NRP-ZK6	1419.0664.03
Six-pole interface cable, length: 5.00 m	R&S®NRP-ZK6	1419.0664.04
USB sensor hub	R&S®NRP-Z5	1146.7740.02
<b>Documentation</b>		
Documentation of calibration values (DCV)	R&S®DCV-1	0240.2187.06
Hardcopy of DCV (in combination with R&S®DCV-1 only)	R&S®DCV-ZP	1173.6506.02
Accredited calibration for R&S®NRQ6 power sensor	R&S®NRP-ACA	1419.0812.00

<b>Warranty</b>		
Base unit		3 years
R&S®NRP-ZAP2		5 years
All other items <sup>1)</sup>		1 year
<b>Options</b>		
Extended warranty, one year	R&S®WE1	
Extended warranty, two years	R&S®WE2	
Extended warranty with calibration coverage, one year	R&S®CW1	Please contact your local Rohde & Schwarz sales office.
Extended warranty with calibration coverage, two years	R&S®CW2	
Extended warranty with accredited calibration coverage, one year	R&S®AW1	
Extended warranty with accredited calibration coverage, two years	R&S®AW2	

## Extended warranty with a term of one and two years (WE1 and WE2)

Repairs carried out during the contract term are free of charge<sup>2)</sup>. Necessary calibration and adjustments carried out during repairs are also covered.

## Extended warranty with calibration coverage (CW1 and CW2)

Enhance your extended warranty by adding accredited calibration coverage at a package price. This package ensures that your Rohde & Schwarz product is regularly calibrated, inspected and maintained during the term of the contract. It includes all repairs<sup>2)</sup> and calibration at the recommended intervals as well as any calibration carried out during repairs or option upgrades.

## Extended warranty with accredited calibration (AW1 and AW2)

Enhance your extended warranty by adding accredited calibration coverage at a package price. This package ensures that your Rohde & Schwarz product is regularly calibrated under accreditation, inspected and maintained during the term of the contract. It includes all repairs<sup>2)</sup> and accredited calibration at the recommended intervals as well as any accredited calibration carried out during repairs or option upgrades.

<sup>1)</sup> For options that are installed, the remaining base unit warranty applies if longer than 1 year. Exception: all batteries have a 1 year warranty.

<sup>2)</sup> Excluding defects caused by incorrect operation or handling and force majeure. Wear-and-tear parts are not included.

# FROM PRE-SALE TO SERVICE. AT YOUR DOORSTEP.

The Rohde & Schwarz network in over 70 countries ensures optimum on-site support by highly qualified experts.

User risks are reduced to a minimum at all stages of the project:

- ▶ Solution finding/purchase
- ▶ Technical startup/application development/integration
- ▶ Training
- ▶ Operation/calibration/repair

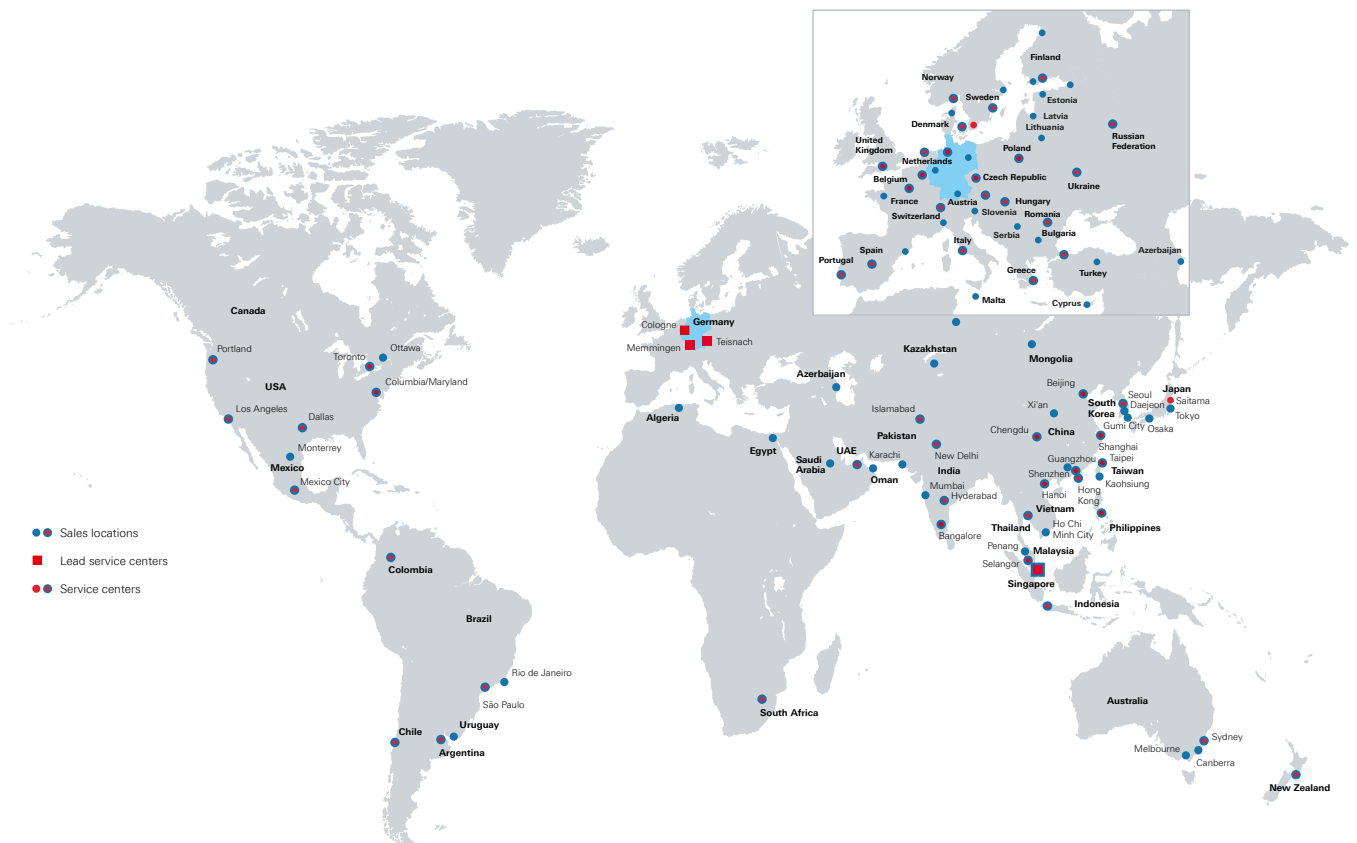

Service that adds value

Worldwide  
Local and personalized  
Customized and flexible  
Uncompromising quality  
Long-term dependability

**Rohde & Schwarz**

The Rohde & Schwarz electronics group offers innovative solutions in the following business fields: test and measurement, broadcast and media, secure communications, cybersecurity, monitoring and network testing. Founded more than 80 years ago, the independent company which is headquartered in Munich, Germany, has an extensive sales and service network with locations in more than 70 countries.

[www.rohde-schwarz.com](http://www.rohde-schwarz.com)

**Sustainable product design**

- ▶ Environmental compatibility and eco-footprint
- ▶ Energy efficiency and low emissions
- ▶ Longevity and optimized total cost of ownership



**Rohde & Schwarz training**

[www.training.rohde-schwarz.com](http://www.training.rohde-schwarz.com)

**Rohde & Schwarz customer support**

[www.rohde-schwarz.com/support](http://www.rohde-schwarz.com/support)



R&S® is a registered trademark of Rohde & Schwarz GmbH & Co. KG  
Trade names are trademarks of the owners  
PD 3607.1888.12 | Version 05.00 | September 2020 (sk)  
R&S®NR06 Frequency Selective Power Sensor  
Data without tolerance limits is not binding | Subject to change  
© 2017 - 2020 Rohde & Schwarz GmbH & Co. KG | 81671 Munich, Germany

3607188812



3607188812/05/00/PDP1/en